

Ballooning

Age 8-12
Educational
Software for the
SPECTRUM
48K
Science; observation, experiment, recording

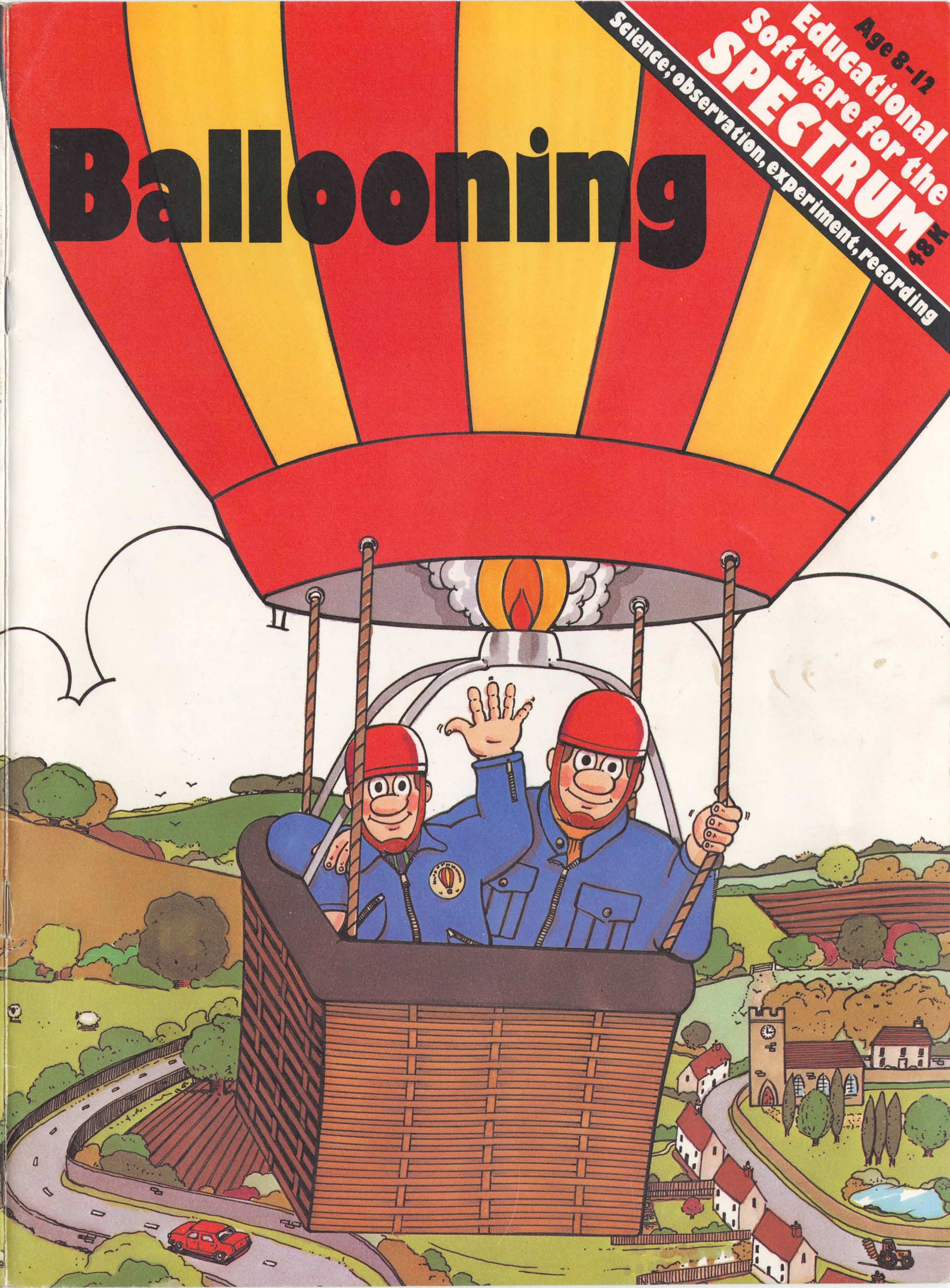

Dear Parents

While children are enjoying using this program they will be learning to experiment, to observe, and to record. These are important scientific skills. The program encourages children to:

- Observe closely the temperature of the air inside the balloon and predict when the burner or vent will have to be used.
- Experiment with the balloon's control.
- Record the results of their experimentation and work out the most efficient use of fuel.

The program, and the information and activities in this book introduce children to a number of scientific principles. They will learn:

- The principle that hot air rises, the concept that a simple operation (such as maintaining a balloon in flight) is determined by the interaction of different variables.
- The importance of applying scientific methods and skills to real situations.

As well as helping your child to learn more about science, this book describes the history of balloons and airships, the problems met by man in developing lighter-than-air flight, and the uses made of balloons today. It also encourages map reading skills and shows children how to make their own balloons. All the way through there are ideas for activities — you can help your children with these, talk to them about what they have read — and play the games with them.

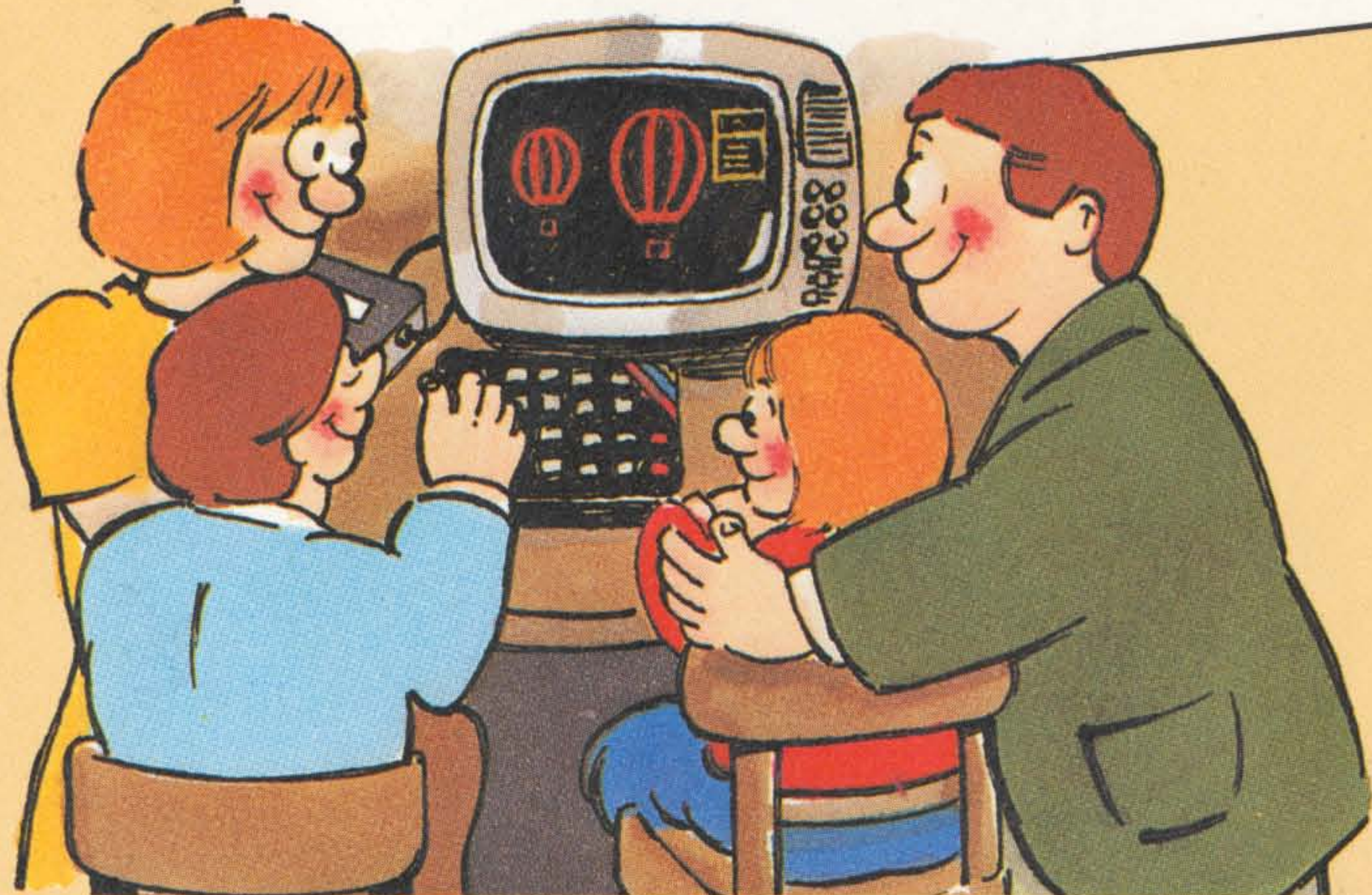

Program design by: Five Ways Software Ltd.
48 Chadcote Way, Bromsgrove, Worcs B61 0JT



Published by: Heinemann Computers in Education Ltd
22 Bedford Square, London WC1B 3HH

LONDON EDINBURGH MELBOURNE AUCKLAND HONG KONG SINGAPORE KUALA LUMPUR
NEW DELHI IBADAN NAIROBI JOHANNESBURG EXETER (NH) KINGSTON PORT OF SPAIN

ISBN 0431 080011

First published 1983

Software ©Five Ways Software Ltd. 1983
Book ©Heinemann Computers in Education Ltd 1983.

All rights reserved. The contents of this cassette and booklet are copyright and may not be duplicated in any form by mechanical, lithographic, photographic, electronic, or other means.

Designed and Produced by Yeldham Muchmore, Ware, Hertfordshire
Printed in Great Britain by Kelsi Print Co. London

Ballooning



History of Balloons and Airships Pages 2 to 7
Planning a Flight Page 10 • Making a Balloon Page 12
Games for One or More People Page 14
Running the Program Page 16

Lighter than air

THE STORY OF BALLOONS AND AIRSHIPS

The first flight

The first successful balloon was invented by two French brothers called Montgolfier. They designed a large linen balloon with a fire beneath to heat the air in the balloon. In 1783, watched by the King of France and a large crowd, the brothers let their balloon go. It had a sheep, a cock and a duck in the basket below. The balloon flew well and the animals landed unharmed. Next a young man called Pilâtre de Rozier experimented with the balloon while it was still fixed to the ground by a long rope. Then, on November 21st 1783, de Rozier and the Marquis d'Arlandes made the first manned free flight. They were in the air for twenty-five minutes, went more than 1,000 metres high and travelled more than 10 kilometres.



Hydrogen balloons

Ten days later two more Frenchmen, Charles and Robert, flew 50 kilometres in two hours and rose to a height of 3,000 metres. Their balloon was filled with a gas, hydrogen. This is 14 times lighter than air and will lift a balloon without being heated. Blanchard and Jeffries flew across the English Channel in another hydrogen balloon in 1785.

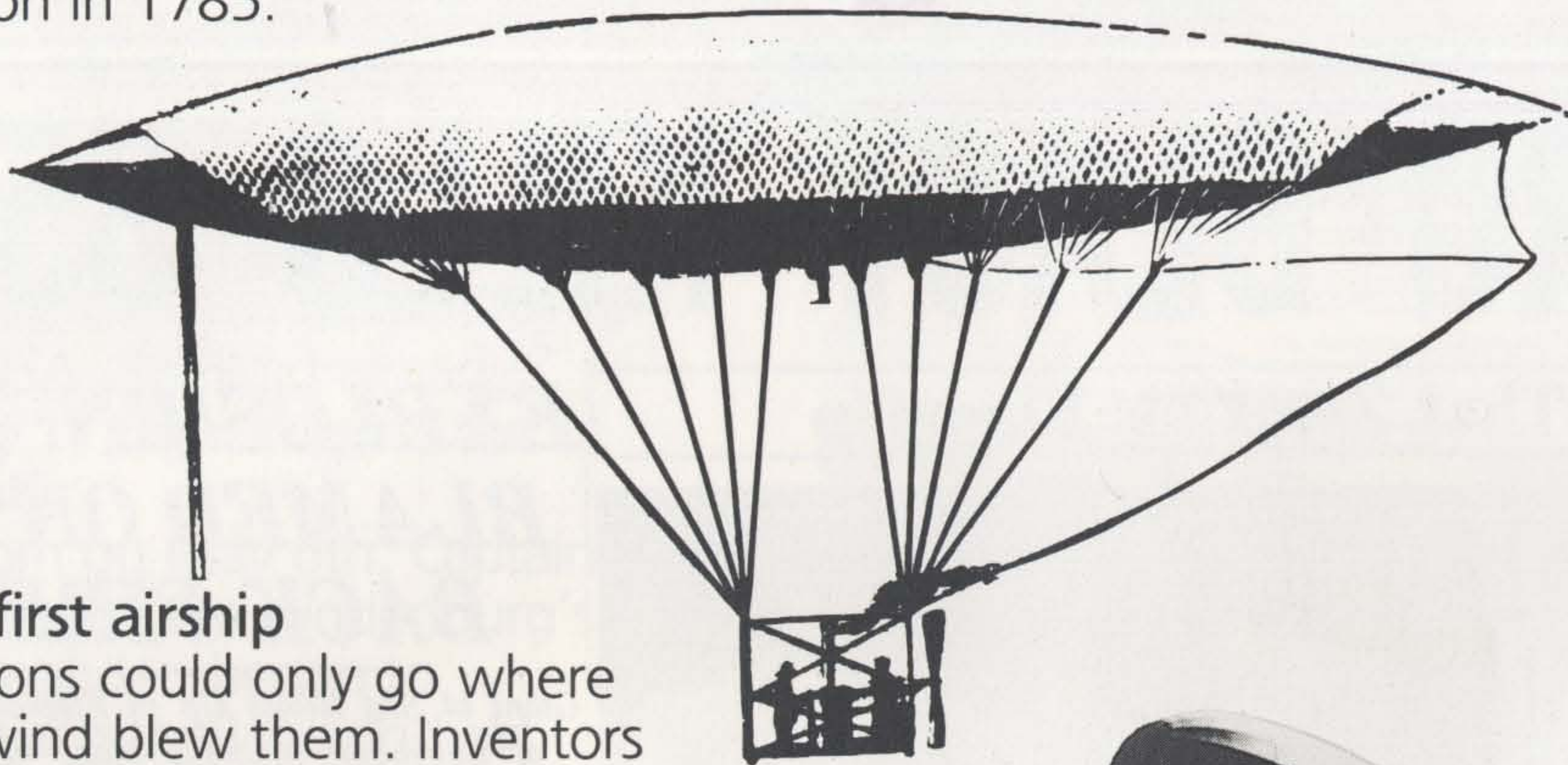

The first airship

Balloons could only go where the wind blew them. Inventors tried hard to make a balloon that could be steered — a 'dirigible'. In 1852 another Frenchman, Henri Giffard, fitted a steam engine to the basket below a gas bag 50 metres long. He could steer his airship — if the wind wasn't too strong! Airships didn't really get going until 1895 when a Brazilian, Alberto Santos-Dumont, fitted a petrol engine to an airship.

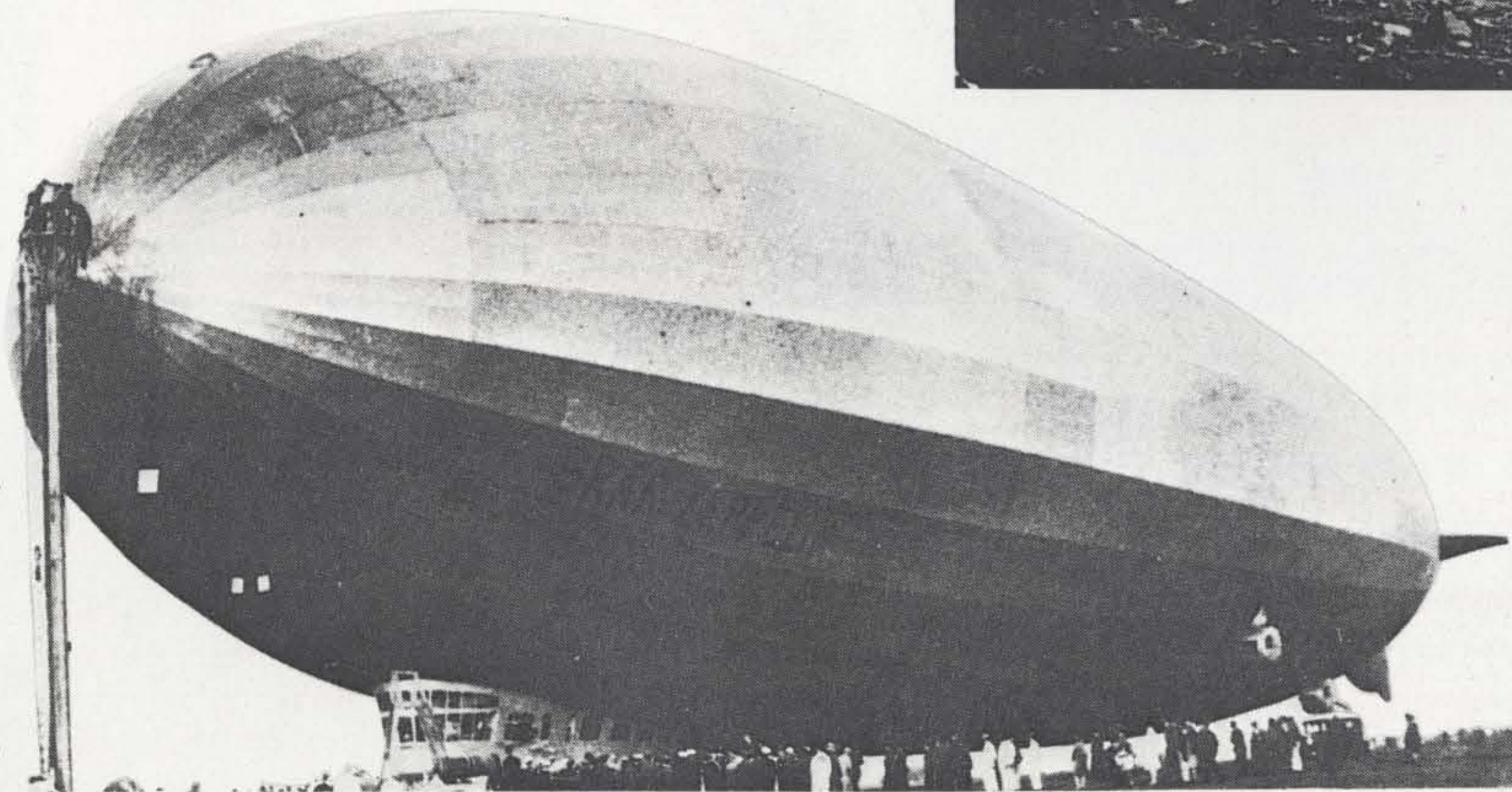

The great airship age

After the First World War, airships were used for carrying passengers and cargo. At this time aeroplanes were small, noisy and uncomfortable but the huge airships had space, quiet, and luxury for their passengers. The Graf Zeppelin was built in 1928 and was one of the most successful airships. She was 230 metres long and cruised at 120 kilometres per hour. She flew all over the world carrying passengers and mail to places as far away as Japan and Brazil.

Mary Evans Picture Library

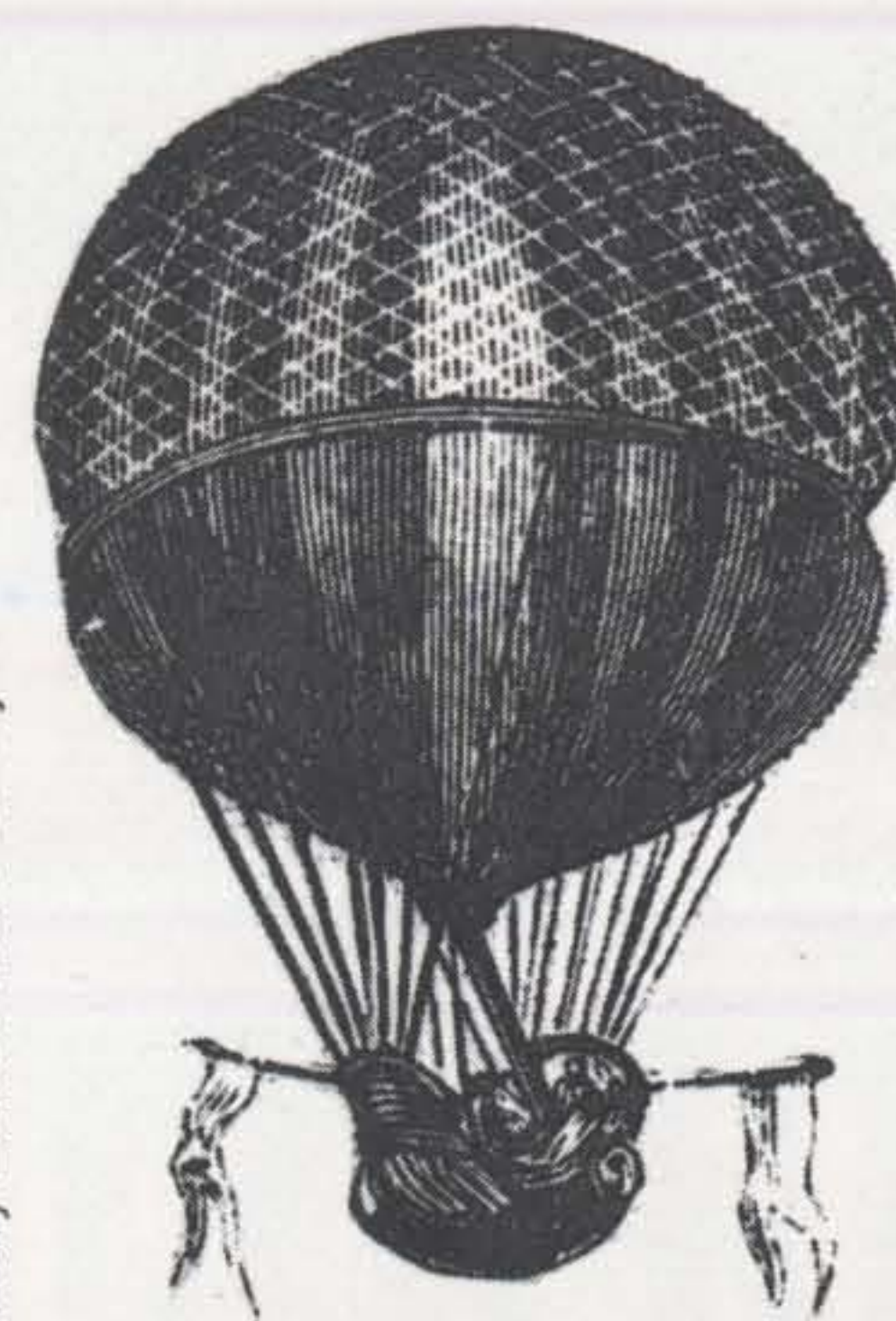

The Zeppelins

The man who did most to develop airships was a German called Count von Zeppelin. He built much larger, more powerful airships with rigid frames outside the balloons. Airships were often called 'zeppelins' after the Count. During the First World War, the Germans used zeppelins for bombing raids on London but they were too slow and too easy to shoot down to do much harm. This one was blown off course and crashed in a Norwegian fjord.

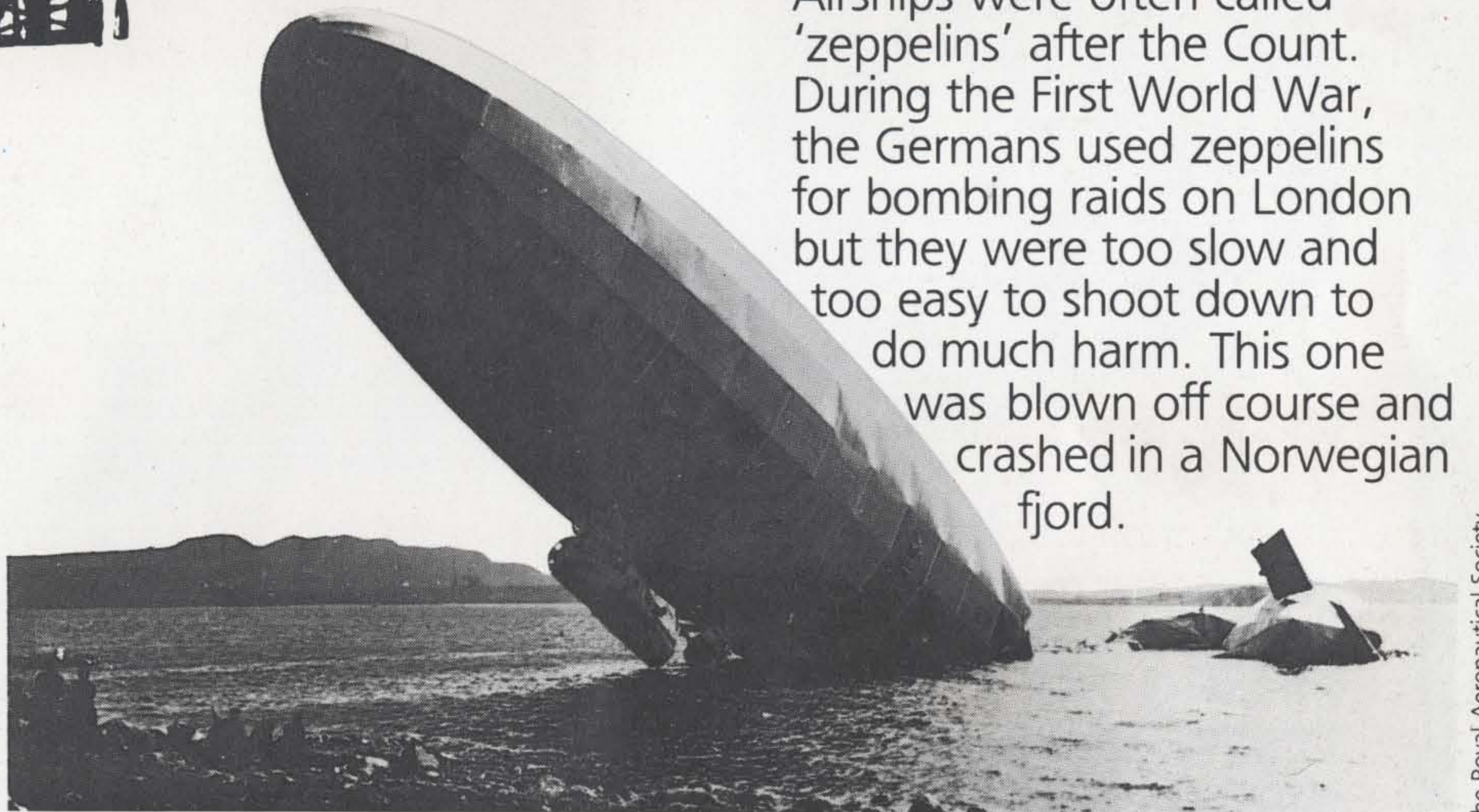

The Royal Aeronautical Society



Airship Industries

The end of the airships

A terrible airship disaster in 1936 stopped the development of airships. Small 'blimps' (non-rigid airships) were used by the US Navy during World War II for escorting convoys and spotting enemy submarines. A few airships still fly today. This one, flying over London, carries up to ten passengers.

Activities

- 1 Ask the oldest people you know what they remember about airships or Zeppelins. Ask them about barrage balloons too.
- 2 How big was the Graf Zeppelin compared with Concorde? Get two other people to help you. Find a long straight clear space on a pavement or in a park. One person can stand still to be the tail marker. Now another person can take 62 very big steps (each one as near a metre as possible), then stop. That's where Concorde would reach to. Now the third person takes 230 metre steps — that's how long the Graf Zeppelin was.



The Philadelphia Inquirer

LATE CITY EDITION

PUBLIC LEDGER

VOL. 216, NO. 127

Published daily and Sunday. Entered as second-class matter at the Postoffice in Philadelphia under Act of March 3, 1879.

PHILADELPHIA, FRIDAY MORNING, MAY 7, 1937

Copyright, 1937, by The Philadelphia Inquirer Co.

abedfgh TWO CENTS

HINDENBURG BLAST KILLS 35

At Exact Moment That Zeppelin Blew Up

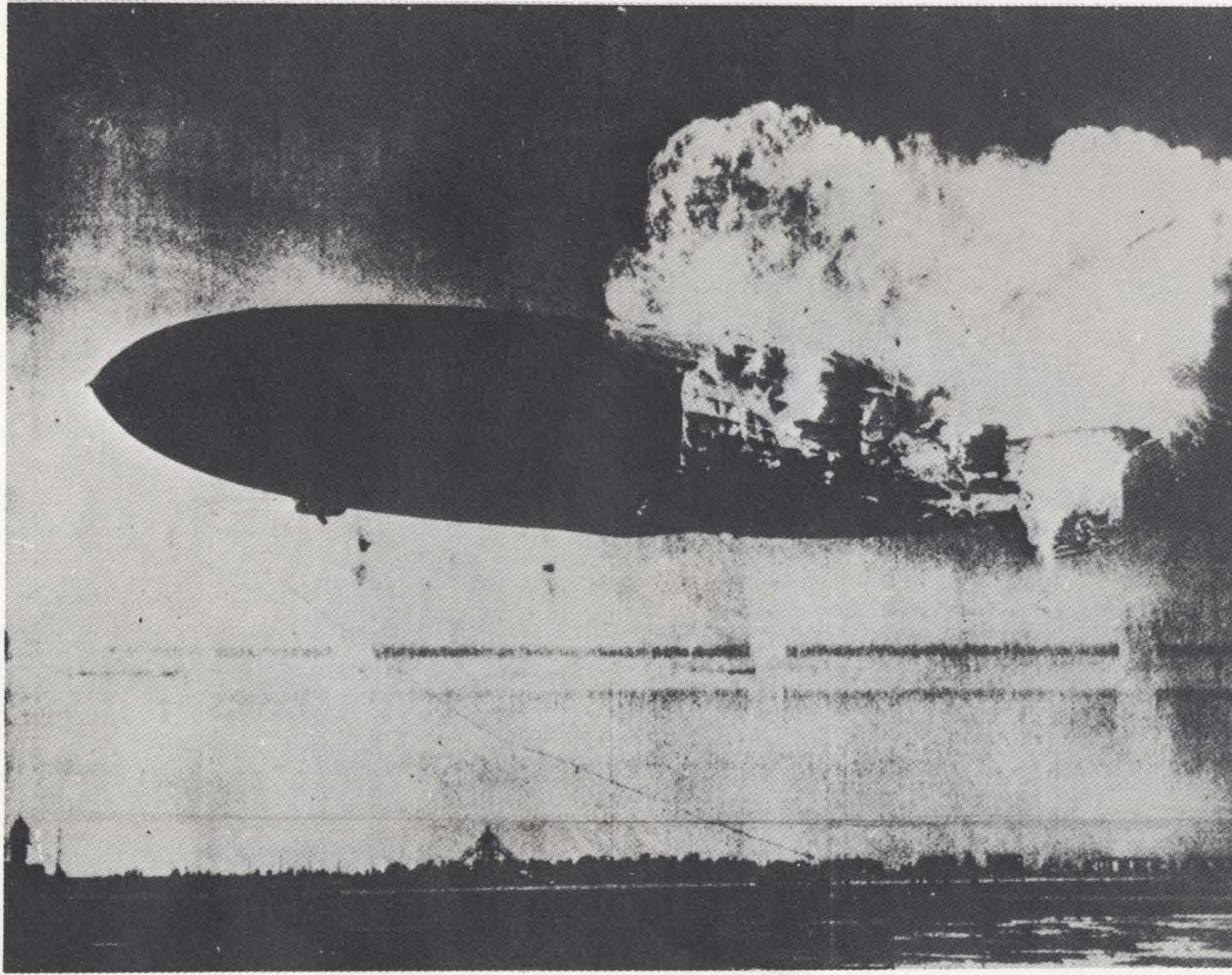

Photo by Murray Becker, Associated Press Cameraman. Copyright, 1937

Doomed Air Queen Caught by Camera as First Explosion Ripped Hull

PASSENGERS BLOWN ALIVE FROM AIRSHIP INTO HYDROGEN SAC BY FIERY EXPLOSION IS BELIEVED CAUSE

Horrified Witnesses See Bodies Hurling to Field From Flaming Zep

By J. TAYLOR BUCKLEY
Inquirer Staff Correspondent
LAKEHURST, May 6.—Stories of horrified eyewitnesses tonight were being pieced together as the tragic epitaph of the dirigible Hindenburg. Survivors, spectators, members of the landing crew, police officials and others—their eyes still starting with the memory of those few flaming moments, and their bodies still quivering—told me their stories. The first survivor able to speak after his experience was Clifford Ocbun, of Chicago. He was hurled from the landing airship by the explosion, but except for shock suf-

In The Inquirer Today

Alto Kendrick	4	Paul Mallon	6
Amusements	23	People's Friend	14
Calendar	26-28-37-38	Pictures	16-17
Cartoons	19	Radio	32
Daily Story	25	Real Estate	32
Deaths	25	Shipping News	35
Durability	20	Silver Road	20
Editorials	14	Society	20
Entertainments	19	Sports	27-28-29-30
Favorite Recipe	18	Used Cars	18
Feature Page	19	Weather	15
Finance	21-32	Westbrook Page	24
Garard's Letter	25	Whispers	26
Inquirer Reporter	25	Woman's Interest	18-19-20-21
Joseph Post	19	Year Figure	19
Local News	19	Your Part in It	19
Market Pictures	21	Stamps	18
Child Aid	19		

'LIKE END OF WORLD' WHEN ZEP EXPLODED

Inquirer Cameraman Tells How He and 200 Others Fled for Lives From Flaming Coffin

Report of 'Red' Plot Sent Squad of N. Y. Police to Lakehurst Field

By DOROTHY D. BARTLETT
Inquirer Staff Correspondent
LAKEHURST, May 6.—Backfire from a single engine, which set aflame leaking hydrogen, was the probable cause of the explosion which tonight tore asunder the giant airship Hindenburg, U. S. Naval authorities and officials of the Zeppelin company agreed. At the same time an air of mystery was thrown about the disaster as Gill Robb Wilson, New Jersey's aviation director, said: "There was something strange about this whole thing." The possibility of sabotage, hinted by Wilson, was strengthened when it became known that a dozen members of the Alien Squad of the New York City detective force were present in the crowd tonight as the Hindenburg was landing. Red Plot Reported "We were here to investigate reports that Red activities might lead to an attempt to wreck the air-liner," declared Arvid Johnson, leader of the squad. Whether the "Reds" he referred to meant American radicals — whose

By JOSEPH NELSON
Inquirer Staff Photographer, who saw Hindenburg explosion, and whose photographs of the disaster appear in this issue.

LAKEHURST, May 6.—A routine assignment—the landing of the giant airship Hindenburg at Lakehurst—tonight turned into a half-hour of flaming horror, and shovels and a score of other photographers and newspapermen closer to death than we have ever been before. How the end of the world will look I don't know, but I think I got a pretty good idea of it tonight. Flames raged within a dozen feet of me. The three explosions which brought doom to the dirigible shook the ground like an earthquake under me. Charred Bodies Piled Up Horribly charred bodies lay piled up before me, as, scarcely able to keep my feet, I snapped pictures of the holocaust all about me. Reporters, photographers, ground crew, and a crowd of persons awaiting the Hindenburg's arrival—about 200 in all—scattered pell-mell as one after the other, the three major explosions rent the air. It was a veritable dash for life—a mad scramble to keep wits and senses in the face of a hameless terror. I served in the World War and saw action in such hell-spots as the Argonne. But never anything like tonight. We were standing in a drifting

rain, all of us, moving our arms to keep ourselves warm, as the grey airship nosed toward her mooring mast at the Lakehurst station. It was a bad evening for pictures, and we thought we wouldn't be able to get anything until tomorrow morning, when the sky had cleared. It was a routine assignment—not

Continued on Page 13, Column 2

15 Survivors In Crew Set To Try Again

By ALLAN CRIST
Inquirer Staff Correspondent
LAKEHURST, May 6.—They are ready to do it again. Fifteen members of the surviving crew of the Hindenburg would not talk of the tragic present tonight, but only of a daring, courageous future in which they see themselves aboard another Zeppelin. As they stood around with their arms in slings and their heads bandaged these sturdy German sailors of the air took the terrible misfortune of tonight as fate. Like good sailors they are ready to fly again. Hendrick Kuben, chief steward.

PHYSICIANS LABOR TO SAVE LIVES OF BLAST SURVIVORS

Naval Air Base Becomes Hospital and Morgue for Those Aboard Zep

By J. CLAYTON COOK
Inquirer Staff Correspondent
LAKEHURST, May 6.—With the terrific explosions still ringing in their ears, doctors at the Naval Air Base here worked frantically tonight to salvage the human life surviving the destruction of the Zeppelin Hindenburg. Dragged from the flaming, heat-twisted wreckage of the giant air-liner, dead, dying and injured filled the emergency hospital here to capacity, while others were rushed by ambulances to hospitals in Monmouth and Ocean counties. 82 Survivors Reported Of 97 passengers and members of the crew aboard the Hindenburg, 82 survived, according to estimates here. But of these, many, it is feared, will die. Clogged telephone lines made it impossible to determine exactly the number and whereabouts of the injured. At a hospital in Lakewood, nine miles from here, a priest was called in to administer the last rites to Captain E. J. A. Lehmann, the dirigible's second in command. His

WRECKED ZEPPELIN 'A FADING BONFIRE,' AS SEEN FROM AIR

'Like Morro Castle Ghost,' Inquirer Reporter Says of Crumpled Ship

By ROBERT BARRY
Inquirer Staff Correspondent
LAKEHURST, May 6.—Two Inquirer photographers and I circled over the Naval Air Station here at 8:30 P. M. some 20 minutes after leaving Boulevard Airport in Philadelphia in a plane chartered by The Inquirer. Not more than ten miles from the scene of the Hindenburg disaster we ran into a driving rain which cut down visibility appreciably, but not so much as to obliterate the funeral pyre that lay beneath us, nor the long lines of automobiles whose headlights were pointed toward Lakehurst for miles in every direction. Like Fading Bonfire At first glance the ill-fated dirigible seemed more like a fading bonfire than anything else. Then, as we circled lower for a landing, it appeared like a ghost of the Morro Castle, which lay aflame nearly four years ago with much the same tragic crumpled list. For nearly a mile the dense black smoke was blown in a northwesterly

EXPLOSION BLAMED ON BACK-FIRE

Giant of Sky Blows Up in Flames at Lakehurst Mooring Mast; 62 Survivors Include Capt. Lehmann and Skipper; Spectators Bowled Over; Heroes Dive Into Inferno.

Two full pages of action pictures of the Hindenburg disaster taken by Inquirer staff photographers at the scene will be found on Pages 16 and 17. Other pictures of the tragedy on Pages 3, 8, 9, 10, 11, 12 and 13.

By GEORGE M. MAWHINNEY
Inquirer Staff Correspondent

LAKEHURST, May 6.—The giant German Zeppelin Hindenburg exploded and plunged to flaming doom on the Naval air station field here at 7:23 o'clock tonight, carrying 35 to 50 men and women passengers and members of her crew to instant, flame-seared death while, with several hundred others, I looked on, deafened and half stunned.

No one knows how many are dead. We have counted the shapeless forms lying stretched in the improvised morgue here. We have counted those pitiful, bandage-swathed figures in the station's infirmary. But estimates are futile in the still-reigning confusion.

I was less than 100 yards from the ship as, gently propelled by her stern motors, she forged steadily toward her mooring mast.

One moment she was a majestic sky-liner, the great red and black swastikas gleaming on her fins. Then a spurt of orange flame, and an explosion that threw me off balance. Furnace-like heat blistered my face, brought blinding tears to my eyes.

Death-rattle Wracks Frame In that moment—the duration of a lightning flash—she was a warped and roaring pile of twisted aluminum junk, the death-rattle of innumerable minor gas explosions wracking her broken frame.

The catastrophe happened with such rapidity that it was a blur rather than a series of remembered incidents.

For two hours, the big ship, a furtive shape prowling the pine-fringed horizon, had been ducking around a spring electrical storm. Then Captain Max Pruss, her commander, radioed the station that he was coming in for the landing.

Out of the northwest she forged. We could hear the mooring officer bellowing orders to the landing crew through his megaphone. Rain was slashing down, but there was a golden break in the West. Not a breath of air stirred. The cloth wind-socks on the lofty hangar roof hung damp and limp in the dead air.

Walking toward the mooring mast I watched as the huge ship—the size of a battleship—drifted in, nose slightly inclined, dripping water ballast. A rear engine "kicked" to throw her nose square to

List of Zeppelin Passengers Dead or Not Accounted For

LAKEHURST, May 7 (Friday) (A. P.)—These passengers aboard the Hindenburg when that ship crashed late yesterday were dead or not accounted for at an early hour today:

Anders, Rudolph.	Ernst, Otto.
Brinck, Birger.	Ernst, Elsie.
Doehner, Hermann.	Fellbach, Moritz.
Dolan, Bertie.	Fannes, John.
Douglas, Edward.	Fannes, Emma.
Erdman, Fritz.	Reichold, Otto.

THE WEATHER
Official forecast—Eastern Pennsylvania: Fair today and tomorrow, slightly warmer tomorrow. New Jersey and Delaware: Fair today and tomorrow, slightly warmer in interior tomorrow.
(Daylight Saving Time)
Sun rises 5:54 A. M. Sets 8:00 P. M.
Moon rises 3:41 A. M. Sets 4:51 P. M.
Other Weather Reports on Page 2

Lost and Found
LOST—On May 3, from auto in vic. 3000 Locust st., silver coat hat bag, cont. 2 keys, ring & bracelet, suitable reward. R. W. BERRY, Long, 521.
LOST—Tan wallet containing \$225 cash, identity card & notes. Reward \$25. Mrs. Kaplan, 3021 W. North st.
LOST—Mr. Amy, Irish setter, 8 mos., 24 lbs., new collar, brass studs. Rev. Mr. 2463
LOST—Ch. silver zipper, containing bag, keys, etc. Terminal, 101. Reward \$10.11.
Other Lost and Found 16a Page 24

One of the most dramatic photographs in history illustrated The Inquirer's front page on Friday, May 7, 1937, after the explosion of the German airship Hindenburg on a rainy evening in Lakehurst, N.J. The disaster sealed the doom of commercial lighter-than-air craft.

THE HINDENBURG DISASTER

What happened

The largest airship ever to carry people was built in 1935. She was called the Hindenburg. She was more than 240 metres long and had a cruising speed of 136 kilometres per hour. She could carry 70 passengers. On May 4th 1937, the Hindenburg took off from Frankfurt in Germany to go to the USA. She had already made 17 flights across the Atlantic.

At 7pm on May 6th, Captain Max Pruss, the Hindenburg's commander, began to approach the landing field at Lakehurst in the USA. At 7.25 the mooring lines came down from the bow and the ship hung in the air, 20 metres from the ground. The passengers stood by the big windows in the airship, waving to their friends on the ground. Suddenly, without warning, a fire broke out and lit the gas in the hull. Within seconds, the stern hit the ground, the bow rose 150 metres into the air and fell slowly, bouncing once, a mass of flames and crumbling wreckage. Passengers and crew leapt

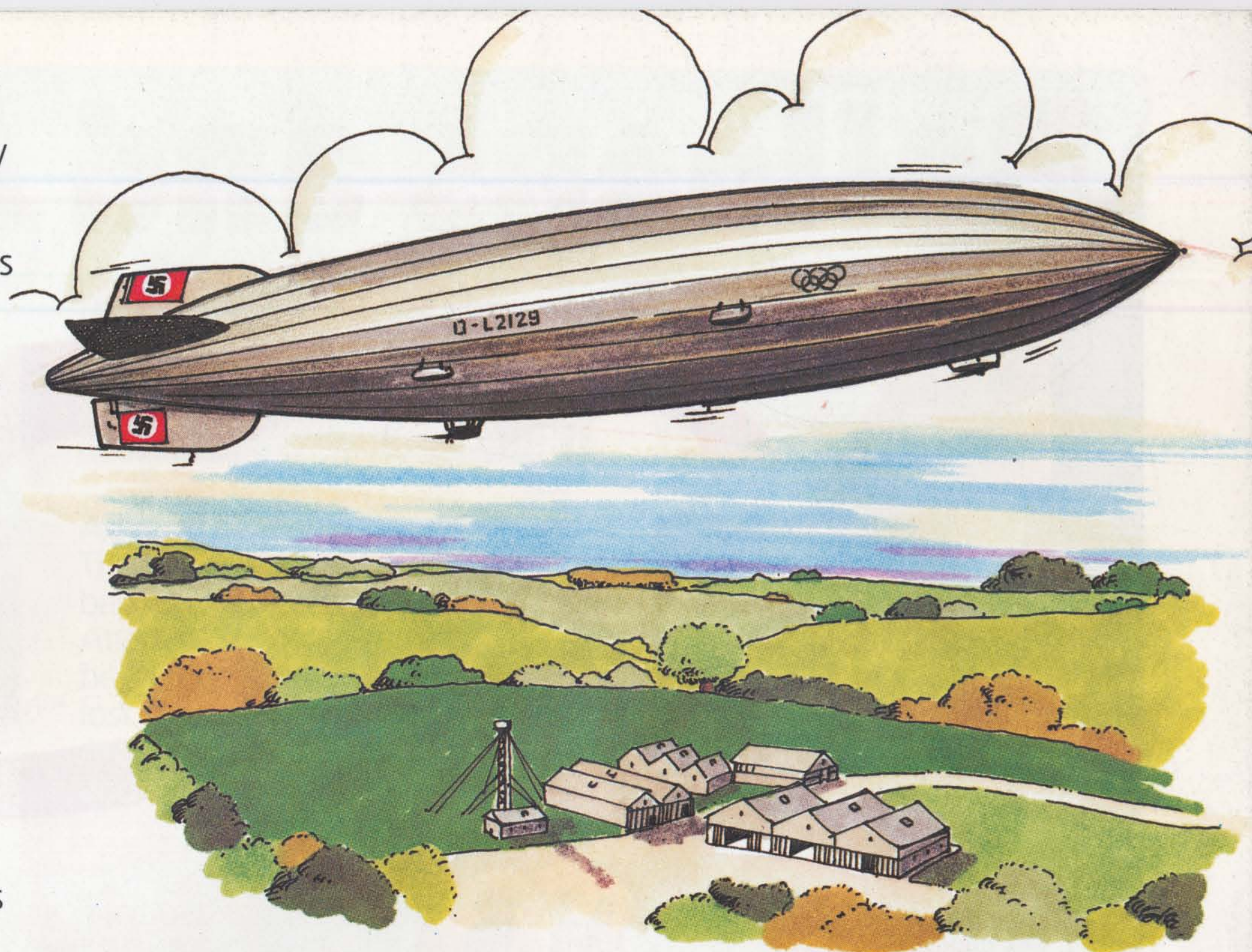

from the wreckage and a minute later the whole airship was in flames. Amazingly 62 people out of the 97 on board survived but 13 passengers and 22 crew died.

Why it happened

The Hindenburg disaster happened because the hull was filled with hydrogen gas.

When mixed with air, hydrogen burns very easily; one little spark would have been enough to set the whole airship alight. The designers knew that it was extremely dangerous to use hydrogen inside the airship. They had planned to use a new gas called helium which was much safer. But helium was only available in America and, because the Americans didn't trust the Nazi government, they refused to sell any helium to Germany. So the Germans had to use hydrogen in the Hindenburg.

The R101

The R101 was the biggest airship ever built in Britain. The designers had a lot of problems with her and the first flight was arranged before she had been properly tested. On October 4th, 1930, she set off on a flight to India and crashed in France, killing 48 people. After the fire only the metal skeleton remained.

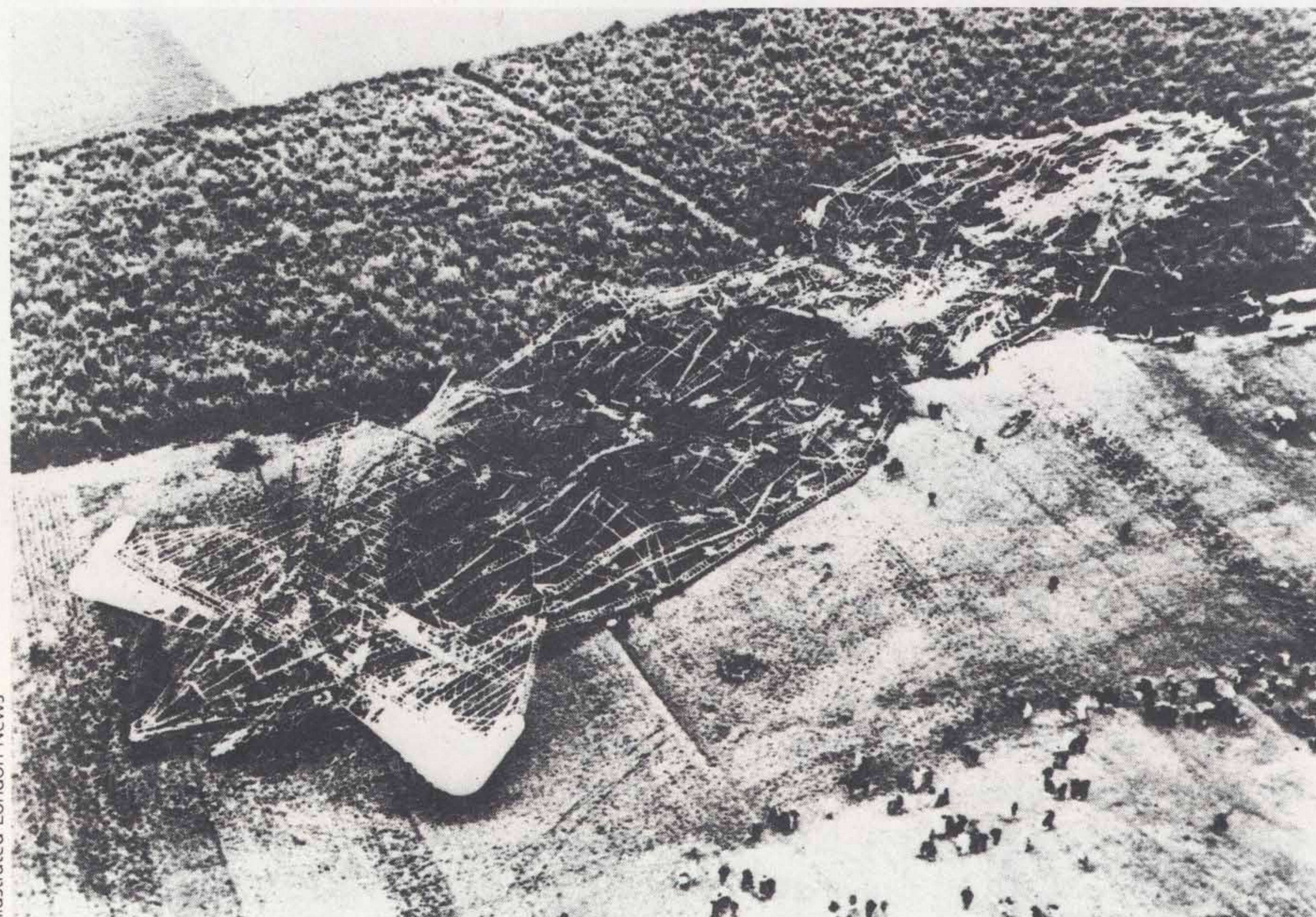

Illustrated London News

Activities

- 1 A large library may have old newspapers (like the one opposite). Ask the librarian to help you find a paper for May 7th 1937, (Hindenburg), or October 5th 1930 (R101) and read the story of the disasters.
- 2 You could make your own newspaper or tape recording describing one of the disasters.

Balloons and Airship



Cameron Ballooning, Bristol

After the disasters in the 1930's there were no more giant airships. Aeroplanes took over. However, some people think commercial airships might be used again one day. Although they are slow, they can lift huge loads (much more than an aircraft can). If they are filled with helium there is no fire risk and they have many advantages. They don't make a noise or pollute the air. They can stop and wait or go backwards and they could land in many places where aeroplanes can't.

Sport

Ballooning has become a popular sport. Some people enjoy the feeling of floating high above the ground in peace and quiet. Other people enjoy the skill and excitement of competition flying and racing.

s Today



Aerial photography

Balloons are sometimes used by people like the Ordnance Survey (who make maps) to take photographs of the ground from the air.

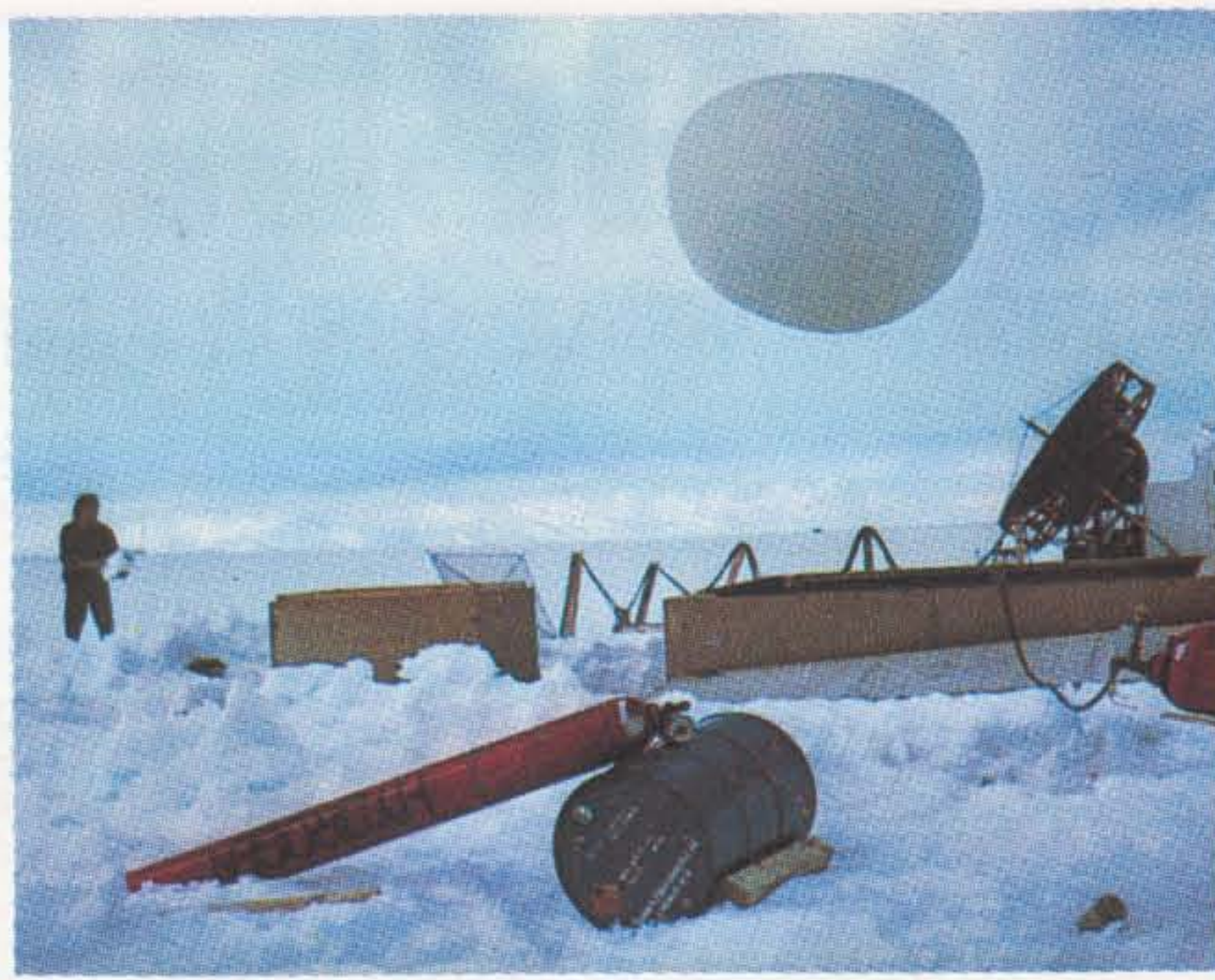

Barnaby's Picture Library

Weather forecasting

Unmanned weather balloons are used to record temperatures and air pressure high up in the atmosphere. Some send their readings back by radio signals, others are brought back to earth by radio control. The readings from these balloons help with weather forecasts.

Adventure

The big challenge for balloonists was to cross the Atlantic. Sixteen attempts have been made and five people lost their lives before three Americans (Anderson, Abruzzo and Newman) crossed from America to France in August 1978 in the **Double Eagle II**. They took nearly six days to fly 3,120 miles.



Barnaby's Picture Library



Crown Copyright reserved

Parachuting

The RAF use balloons for making parachute jumps. The balloon provides a stable base to jump from. This is important when learning to parachute.

Advertising

Many companies have hot-air balloons for advertising. These come in some strange shapes: ice-cream cones, spark plugs, jeans, light bulbs and even a busby balloon. Goodyear has a helium filled airship which is sometimes seen in this country.

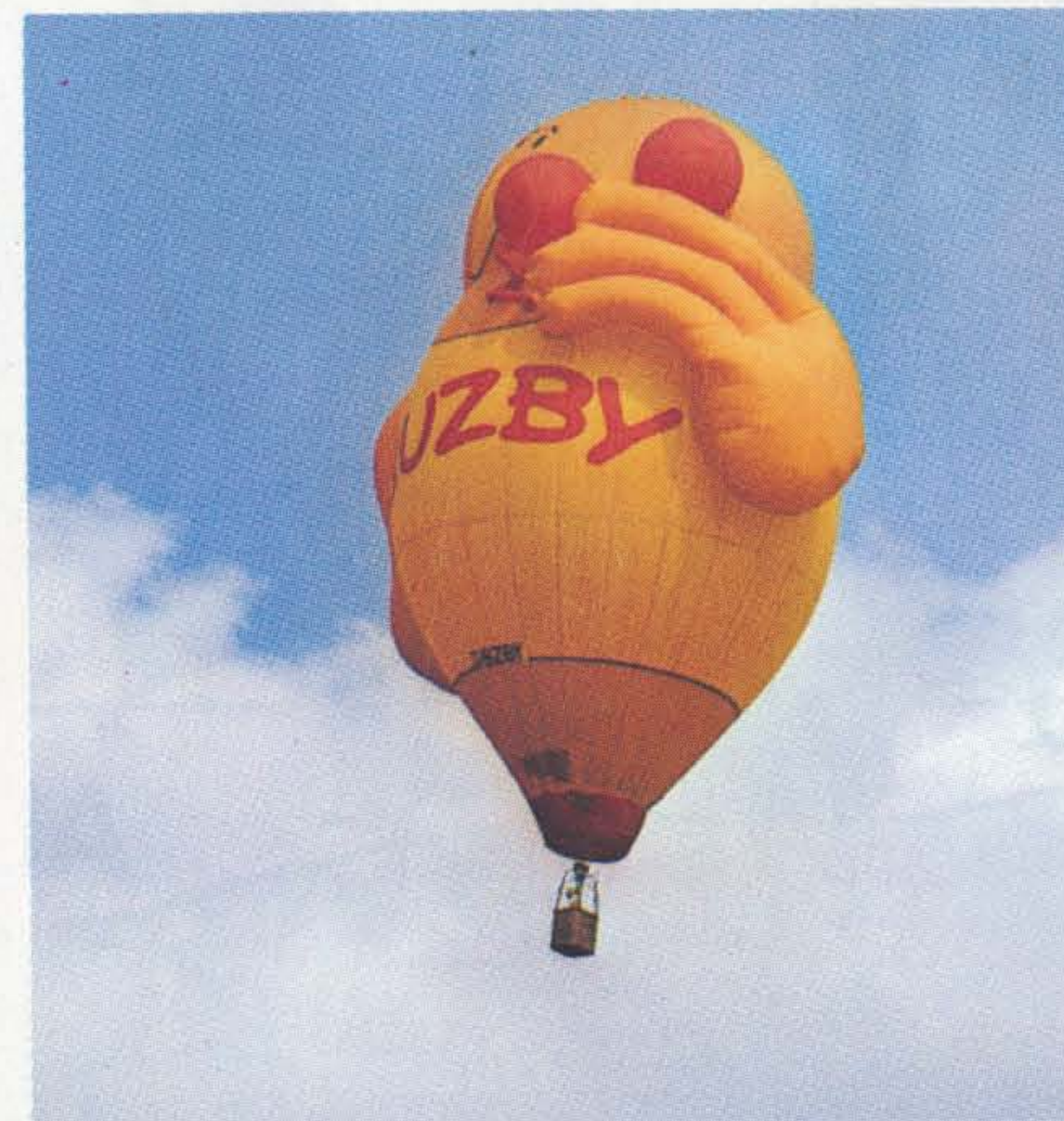

Barnaby's Picture Library

Activities

- 1 Can you think of any other ways in which balloons could be used? Talk about this with your family.
- 2 Design your own airship and compare it with a friend's ideas. What would you use your airship for? Where would you fly to in it? You could make up a brochure to persuade other people to travel in your airship. What would be the most important things to tell them?
- 3 Design a balloon which could be used to advertise something and still fly.

How does a hot air balloon work?

When air is heated it rises. This scientific fact was first used to fly a balloon in 1783 and it is still used today, two hundred years later.

Launching a hot air balloon

- 1 The balloon is made of silk and has a large hole at one end. It is spread on the ground and partly filled with cold air which is blown into the hole by a powerful fan.
- 2 When the balloon is partly full of air, a burner is lit to heat the air inside the balloon. The balloonist has to make sure that the flame does not burn the balloon itself.
- 3 As the air gets hot, it rises and slowly lifts the balloon off the ground and into the air. A large balloon can take 15 minutes to fill. Once the balloon is in the air and high enough, the balloonist turns off the burner. If the balloonist wants to fly lower, he or she opens a vent which lets some of the hot air escape.

Temp

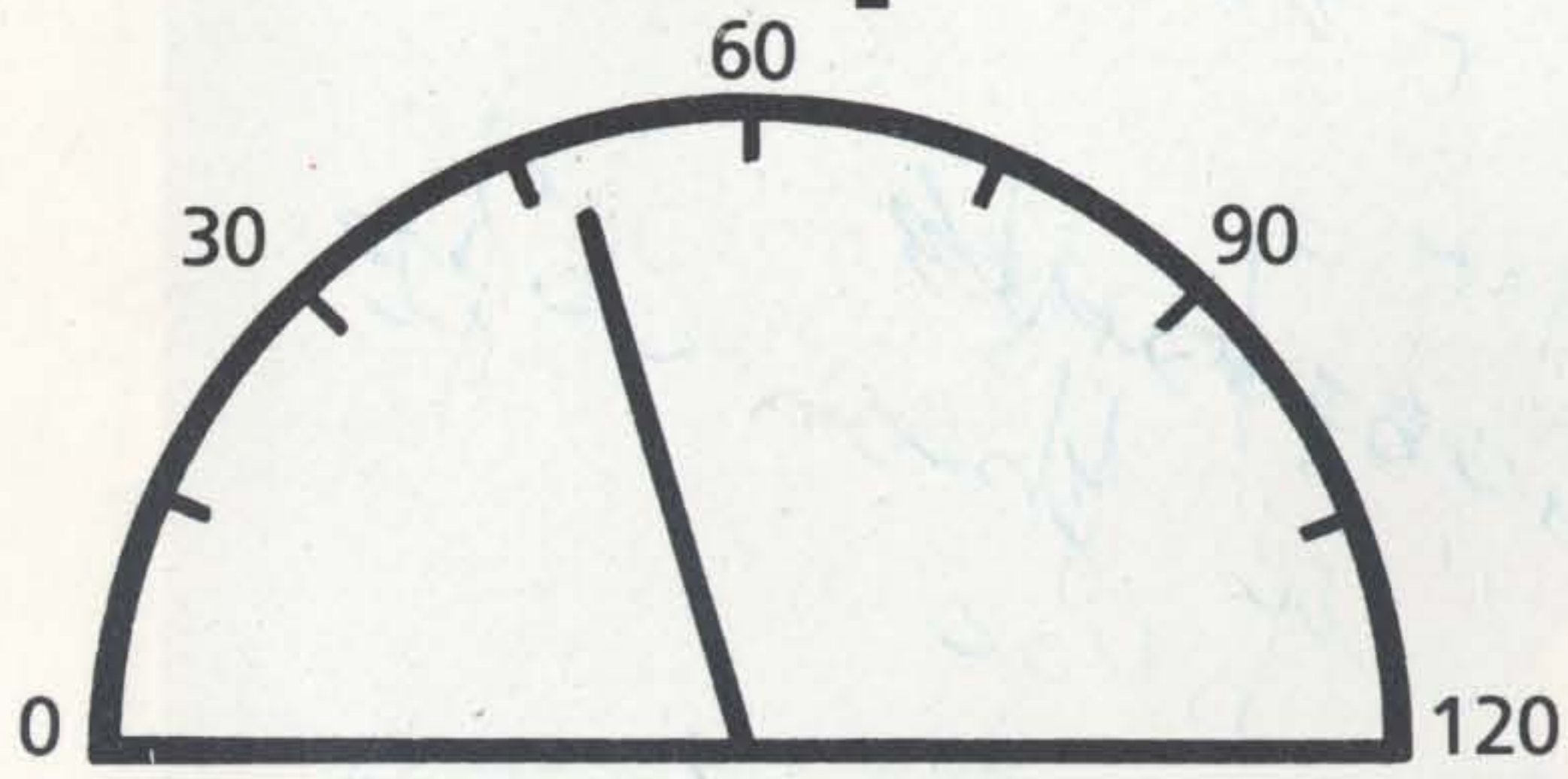

Temperature

This shows the temperature of the air inside the balloon and helps the balloonist to see whether the burner or the vent should be used.

Climb

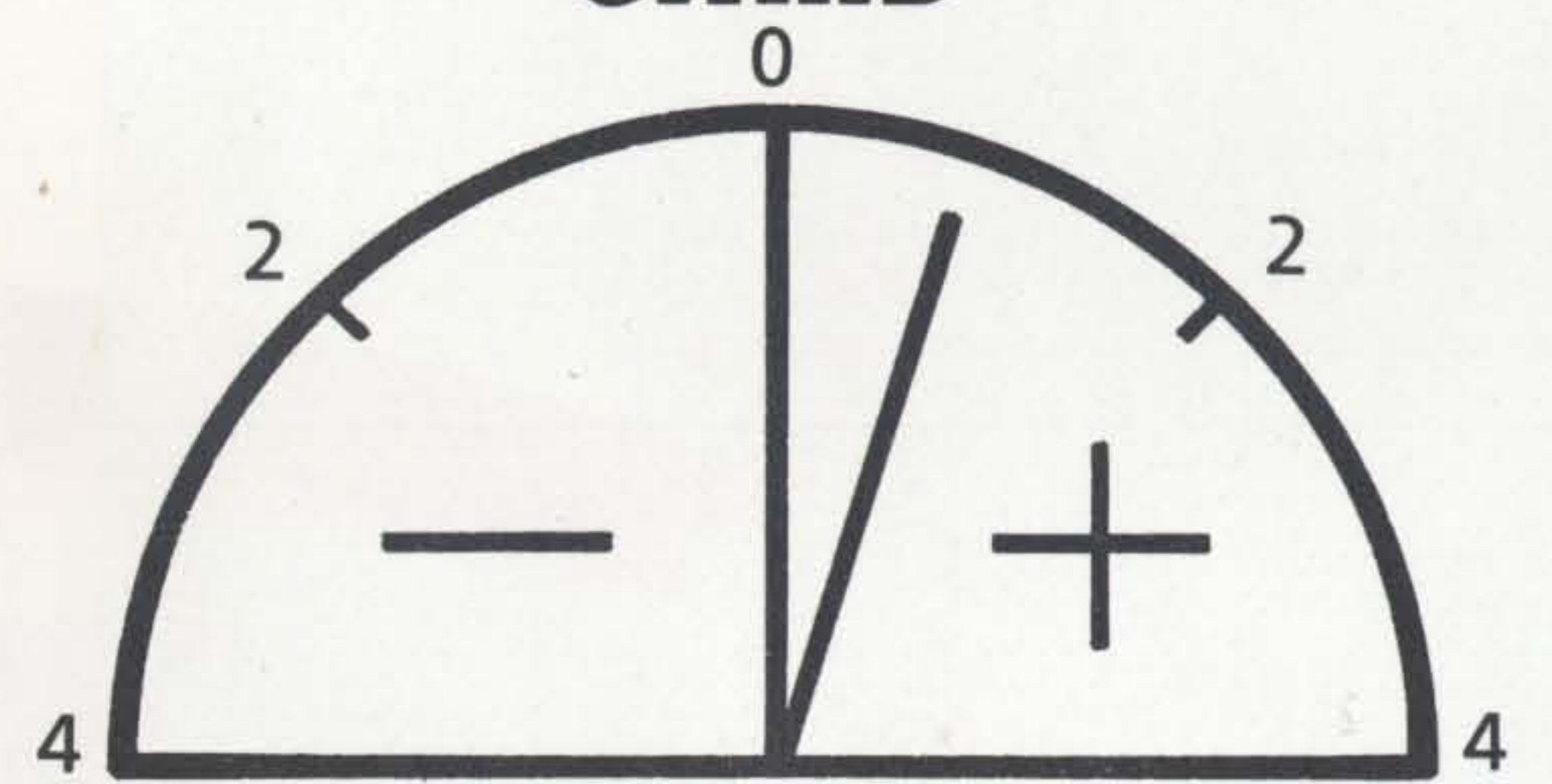

Climb/fall

This dial shows whether the balloon is rising or falling. If it is rising, the arrow is on the + side of the dial. If the balloon is falling, it is on the - side.

Alt

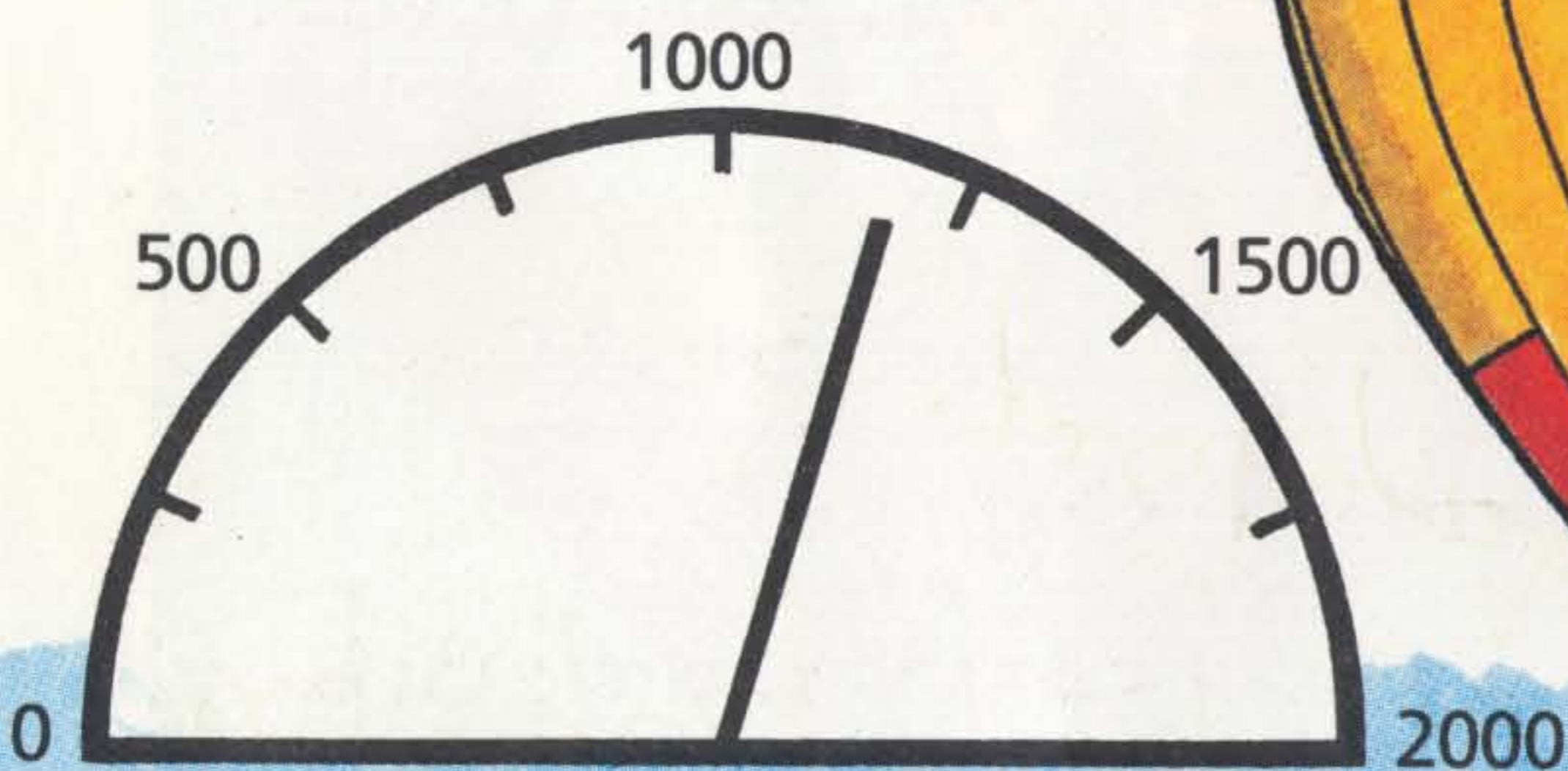

Altimeter

This tells the balloonist the height of the balloon above sea level. It does not show the height of the balloon above the ground.

Fuel

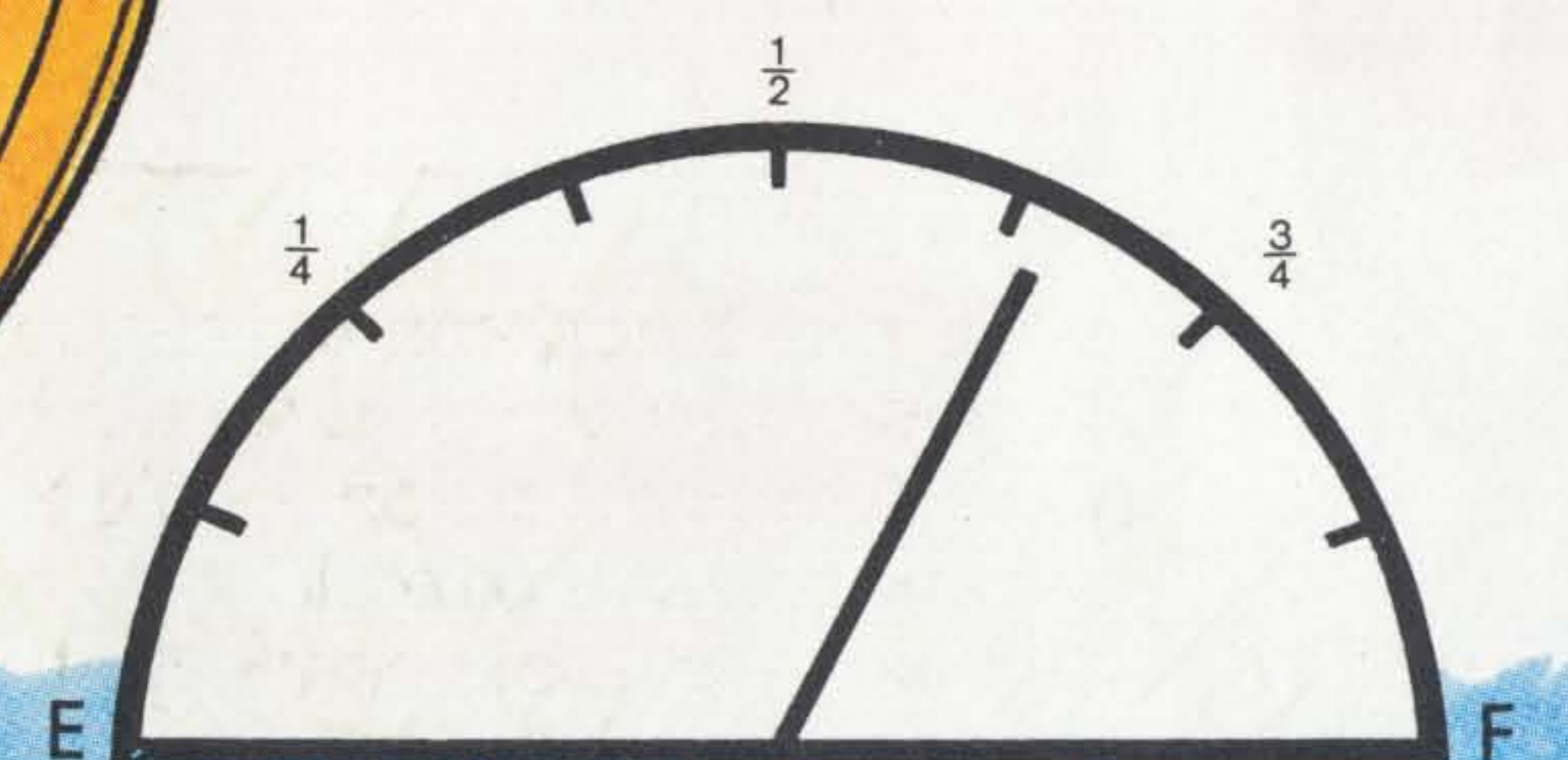

Fuel

This dial tells the balloonist how much gas is left in the cylinders. This is the gas, usually propane, which is burnt to heat the air inside the balloon.

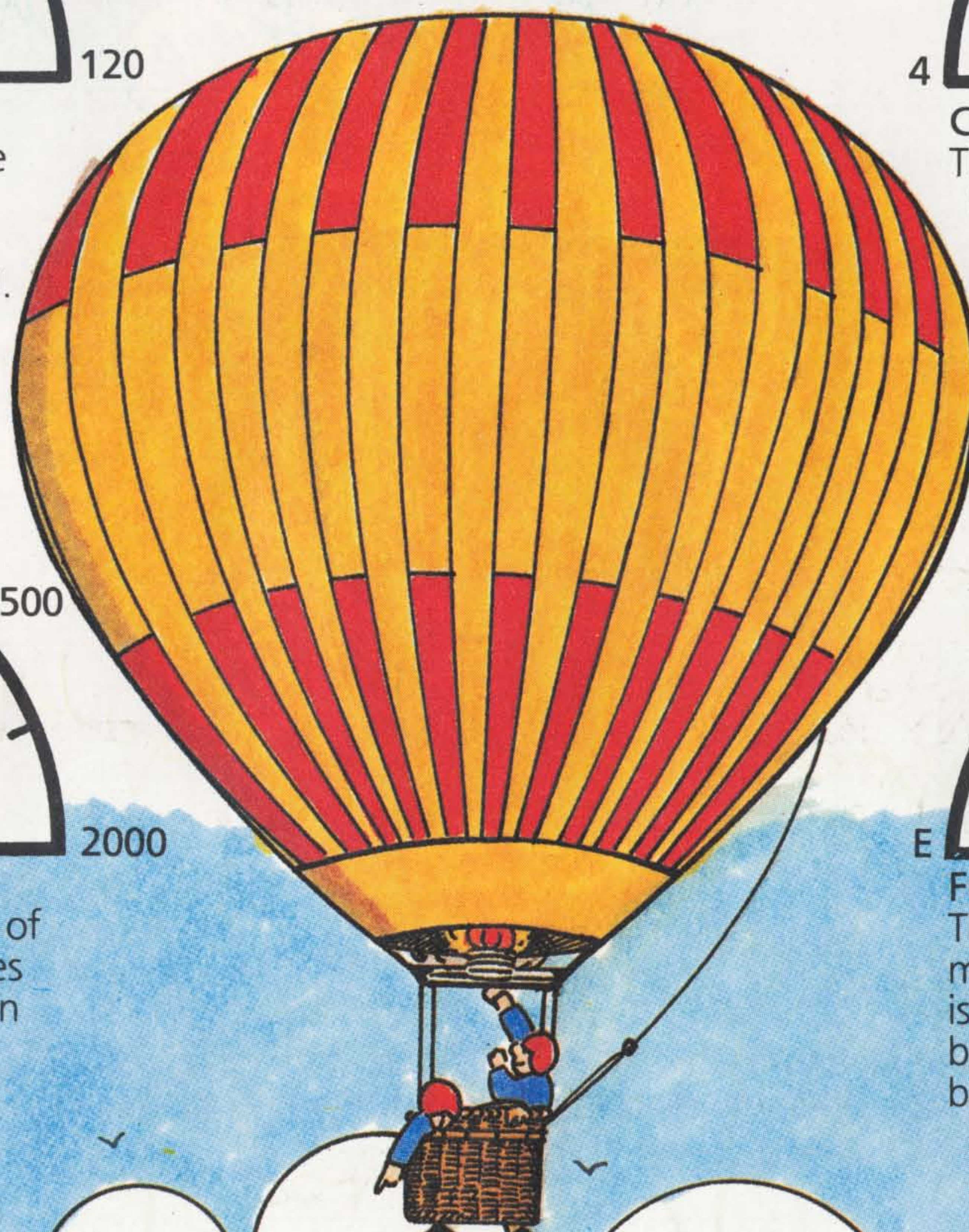

ALTITUDE

HEIGHT

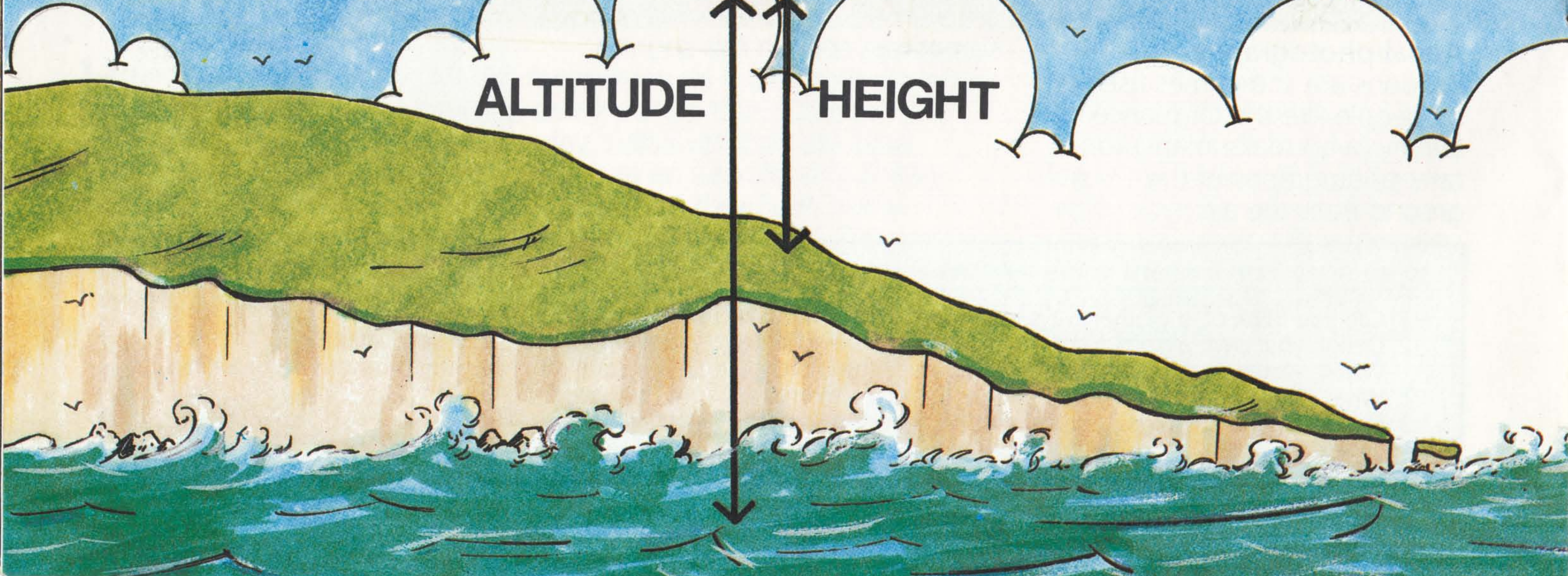

Learning about your balloon

As a balloonist you have to be in control of your balloon all the time. Because the temperature of the air inside the balloon is the only thing which you have direct control over it has to be watched very closely. If the air is too hot you will climb very quickly. If the air is too cold you will fall through the air out of control.

You can experiment with the balloon to find the temperature which will give you the most control over your craft. This can be done by recording the altitude of your balloon as your voyage progresses. In a real balloon the altitude would be recorded with an instrument called a barograph. A barograph makes a trace (rather like the one below) on graph paper which is a record of the altitude of the balloon during the course of a flight.

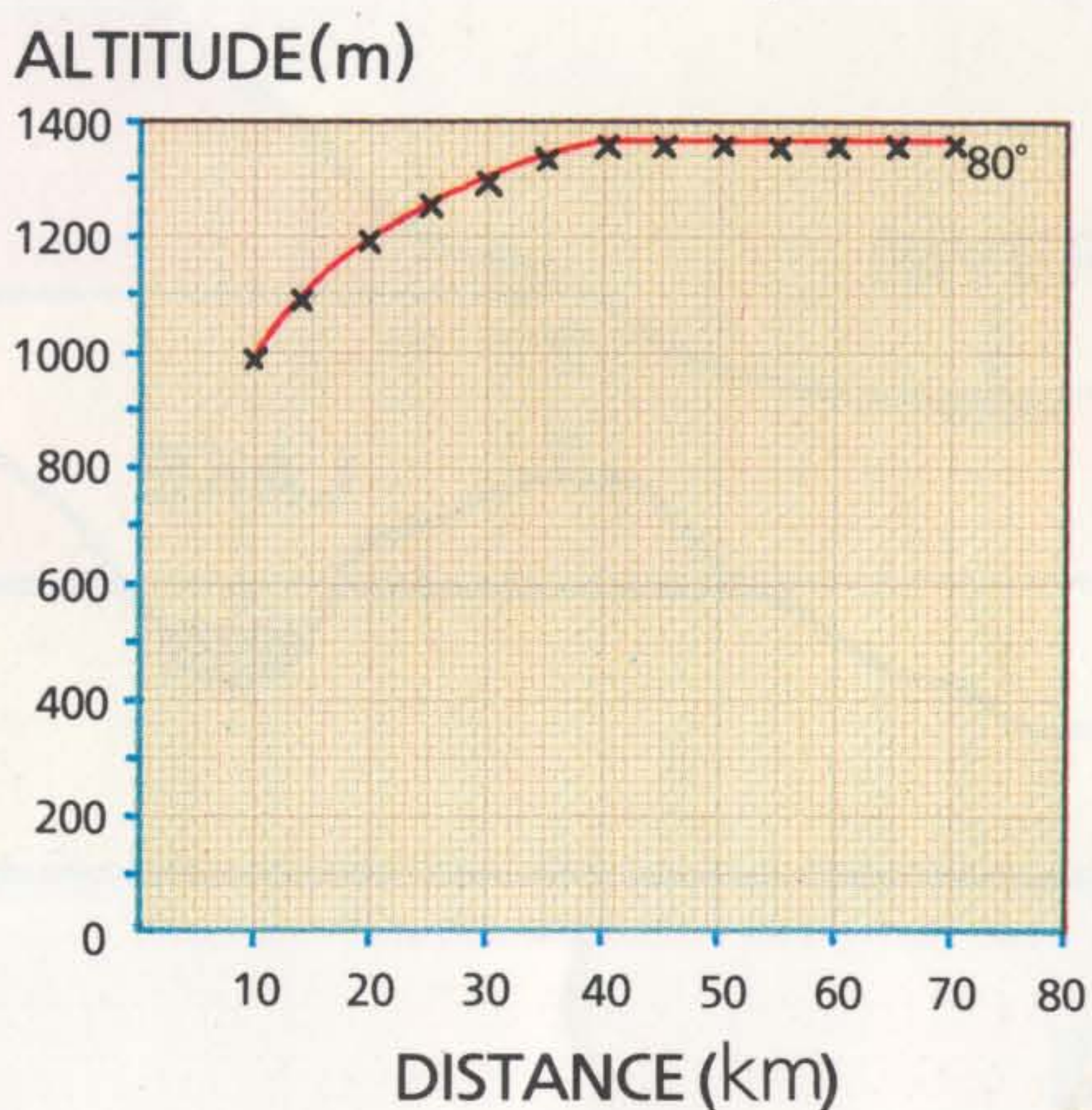

Select 'Flying school' from the program and fly the balloon to well above the ground (1000 metres for example). Keep the temperature at a steady 80°C.

Stop the balloon every 5km by using the **M PAUSE** key and record the altitude on a graph like the one shown.

Press the **C ? CONT** key to continue with the experiment.

Once you have produced a trace for the balloon when the temperature is 80°C you should now repeat the experiment at a different temperature. Try 60°C, 70°C, and 90°C. Record these traces on the same graph so that you can easily compare how the balloon behaves at all these temperatures.

Activities

- 1 From your barograph traces you will see that for each temperature the balloon will fly level at a different altitude. Can you think why this should happen?
Hint: A hot air balloon is able to float in the atmosphere because the hot air inside the balloon weighs less than the surrounding cold air.
The higher into the air we go the thinner (less dense) the air becomes. Can you see why we need a hotter balloon to travel at a higher altitude?
- 2 The world altitude record for a hot air balloon, set in 1980, is an incredible 16,861 metres. How much higher than Mount Everest is this? What special equipment would you need to take with you if you were going this high?
- 3 If you were able to climb at a steady rate of 2 metres per second, all the way to 16,861 metres, how long would it take to reach the record height?
- 4 Think about the balloons you know. Are the ordinary balloons that you have at parties lighter than air? What about the balloons you sometimes see at fairs (people tie labels to them, before letting them go)? What are these two different kinds of balloon filled with? Talk about this with your family.
- 5 Cut a spiral from a piece of foil. Make a hole in the middle with a needle or pin and tie a piece of thread through it. Hold the spiral in the air. Now hold it over a radiator or something hot (NOT over a flame of any kind) What happens? Why?

Planning a flight

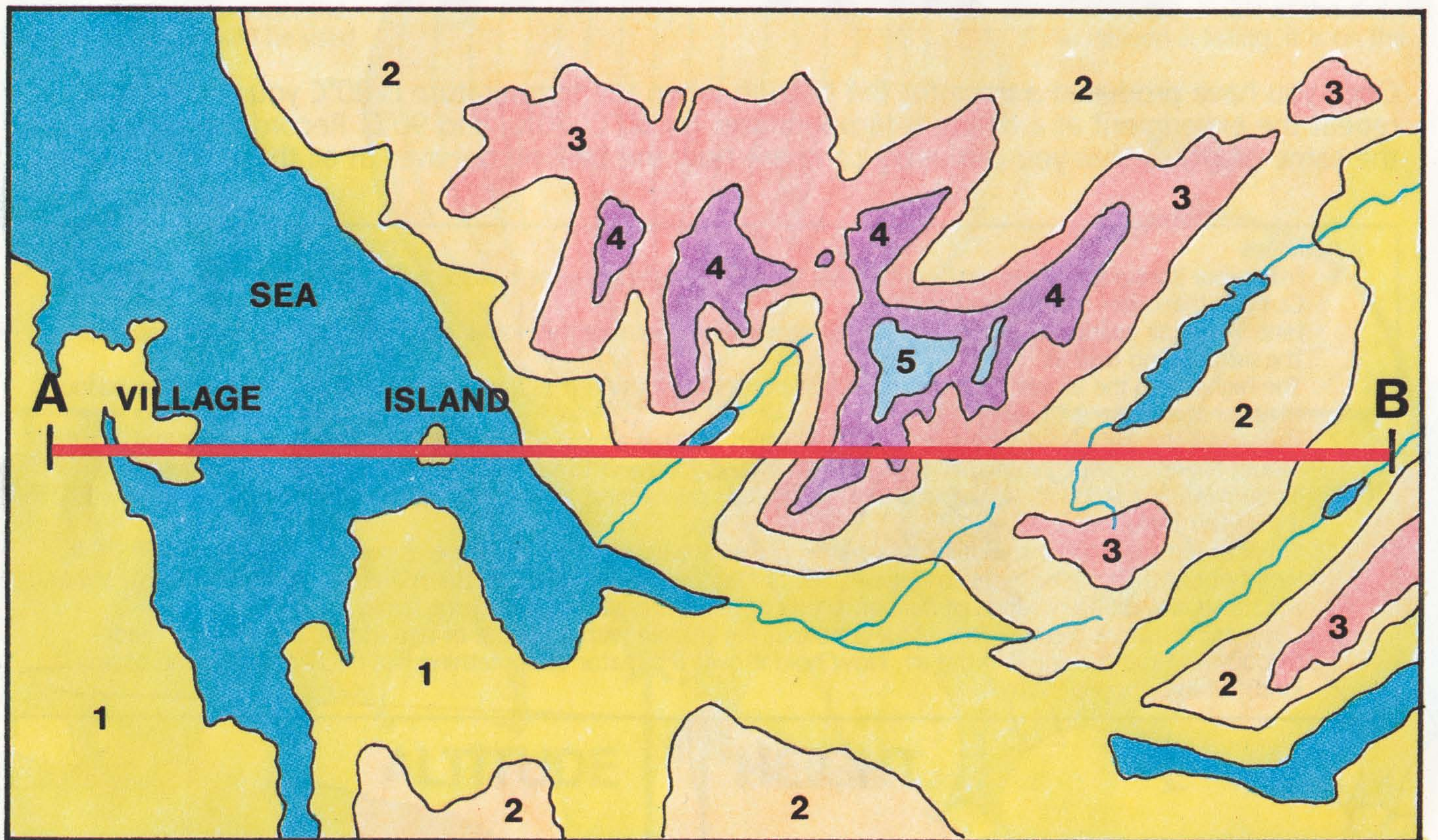
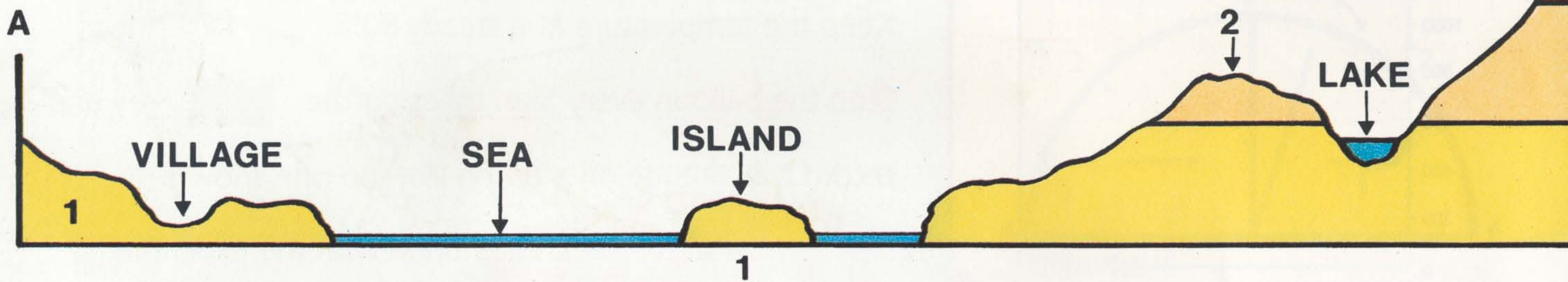

Before making a flight, balloonists find out the direction of the wind and its speed. They then look at the map to work out where they will be blown to. From the map they can work out which hazards lie in their way. Mountains, church steeples, electricity pylons and airports all have to be avoided. When they are in the air, balloonists can look out for features on the map to find out how far down wind they have drifted. Planning is also very important when it comes to landing; not among houses, not over water, not in a tree, and not in the field of farmer's crops. It is always nice to land near a road so that the balloon can be collected easily.

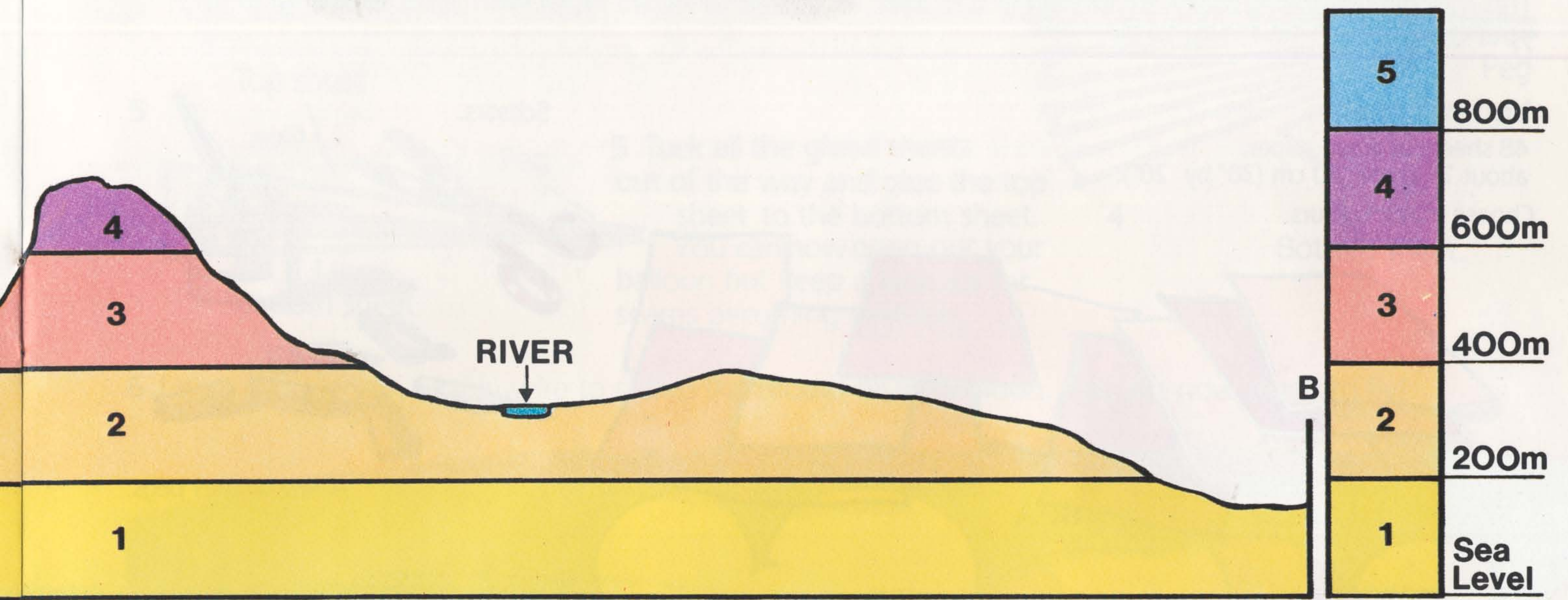

B

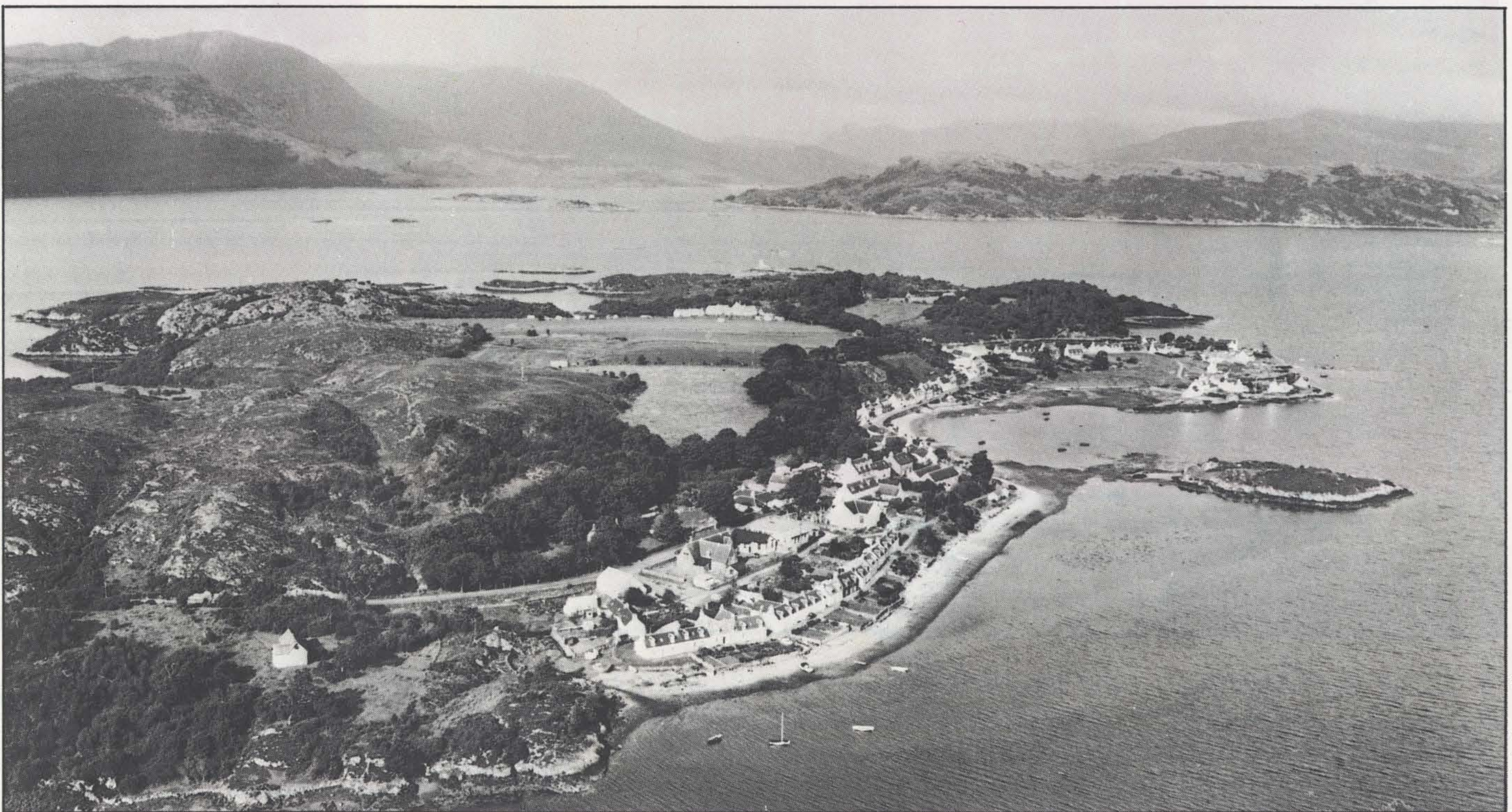

A

Activities

- 1 Look at the aerial photograph on this page and imagine that this is the view downwind from your floating balloon. The direction of your flight is marked on the map between A and B. What can you see from the balloon that is marked on the map? What other features will you pass over that you cannot see yet?
- 2 The diagram at the top of the page is a cross section along the direction of the flight, A to B. How high is the highest land that you will cross?
- 3 Try to get hold of the Ordnance Survey map for the area around your home. Where would you start and finish a balloon flight. In which direction would the wind have to be blowing? What else would you take with you on your flight?

Make your own balloon

This hot air balloon is beautiful and easy to make. A couple of hours work with scissors and glue and your balloon will be ready to fly

You will need

48 sheets of tissue paper, about 76 cm by 50 cm (30" by 20").

Choose bright colours.

Scissors.

Glue.

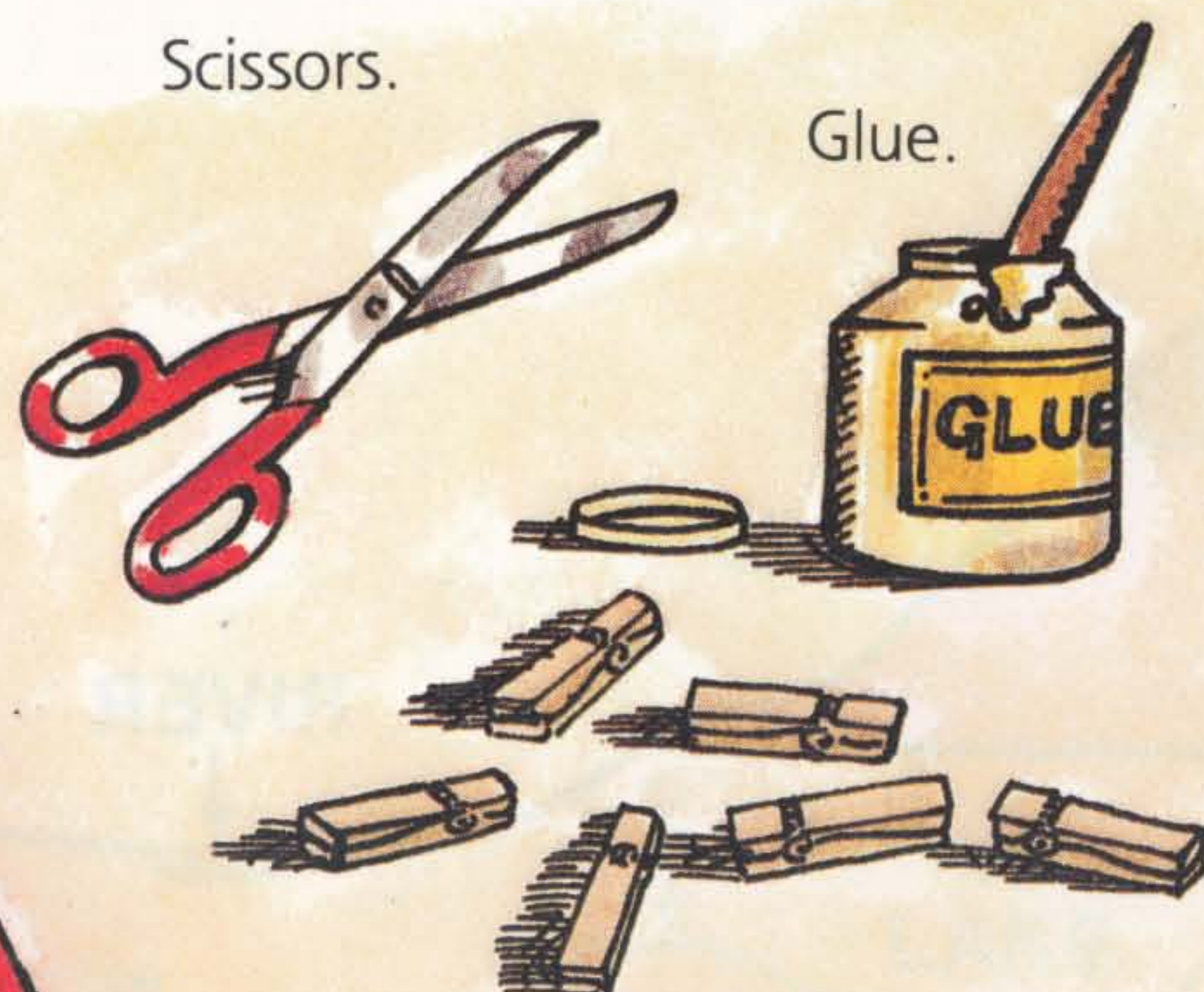

A few clothes pegs.

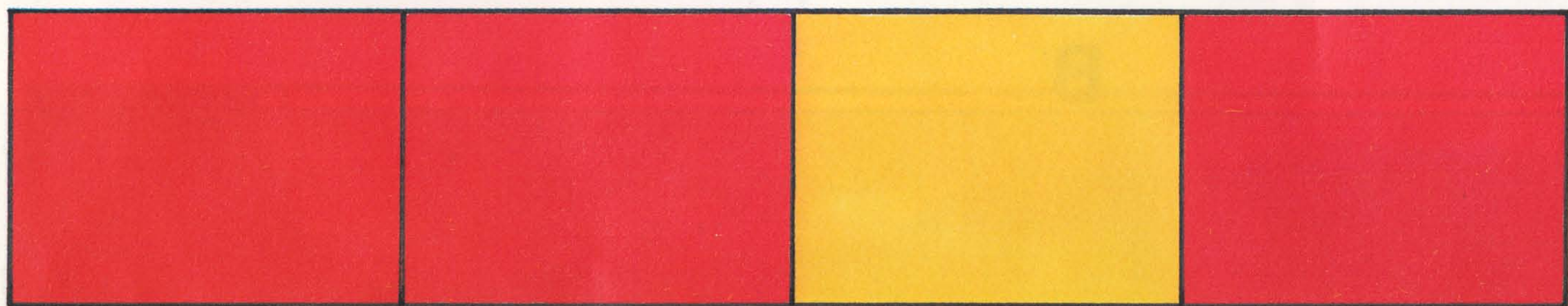
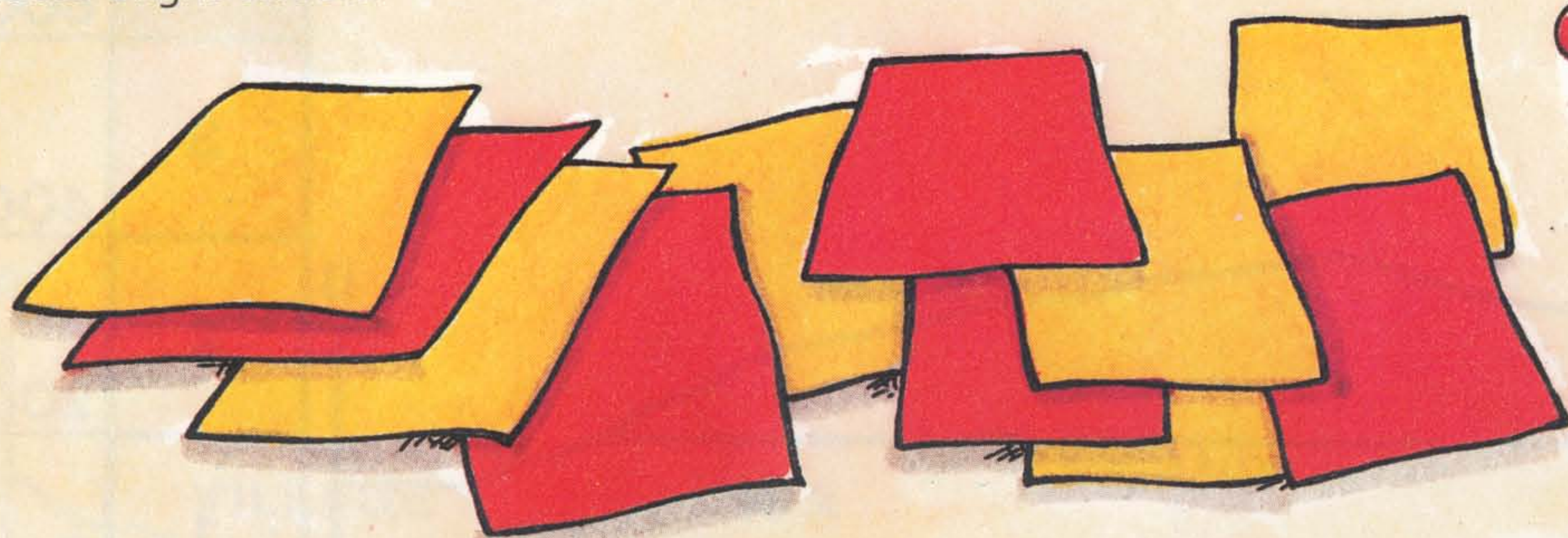

1 Lay out four sheets of tissue paper end to end. Glue the sheets together, allowing an overlap of between one and two cm, to make a long panel.

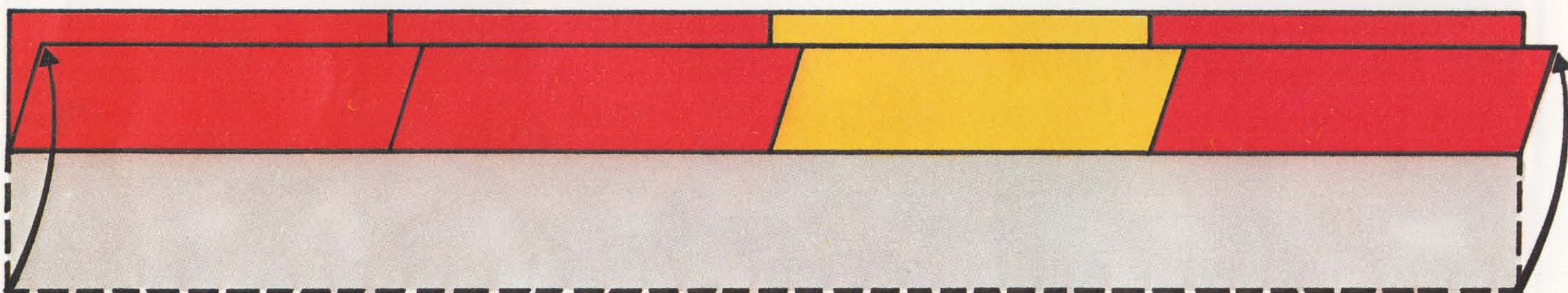

2 Make twelve of these long panels. Fold each panel along its own length. Stack the folded panels on top of each other. Use the clothes pegs along the folded edge to keep all the sheets together.

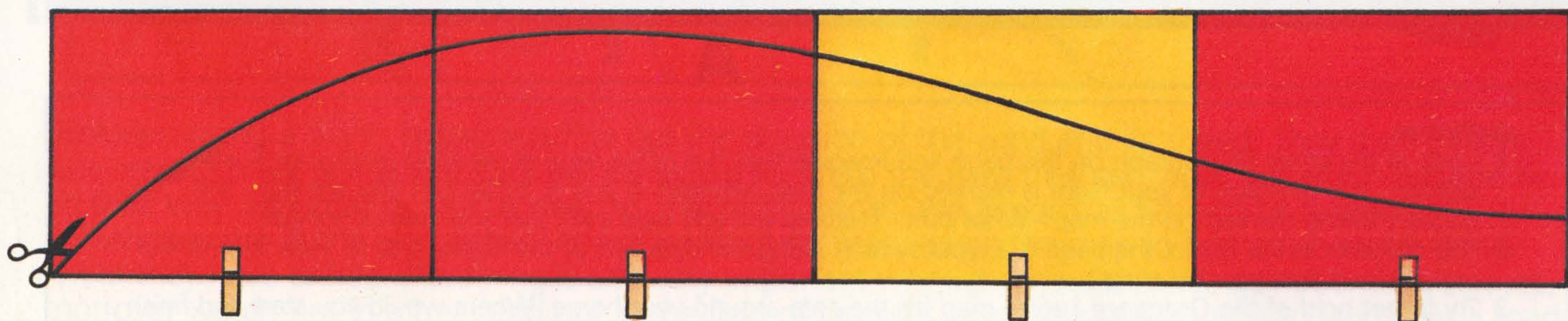

3 Copy the outline shown onto the top sheet. It does not matter if your outline is not exactly the same as long as it is a smooth curve. Carefully cut along the line cutting through all the sheets at once.

4 Fold back the top sheet then glue the edge of the second sheet to the edge of the sheet below. Glue all the sheets together in pairs allowing about one cm. overlap.

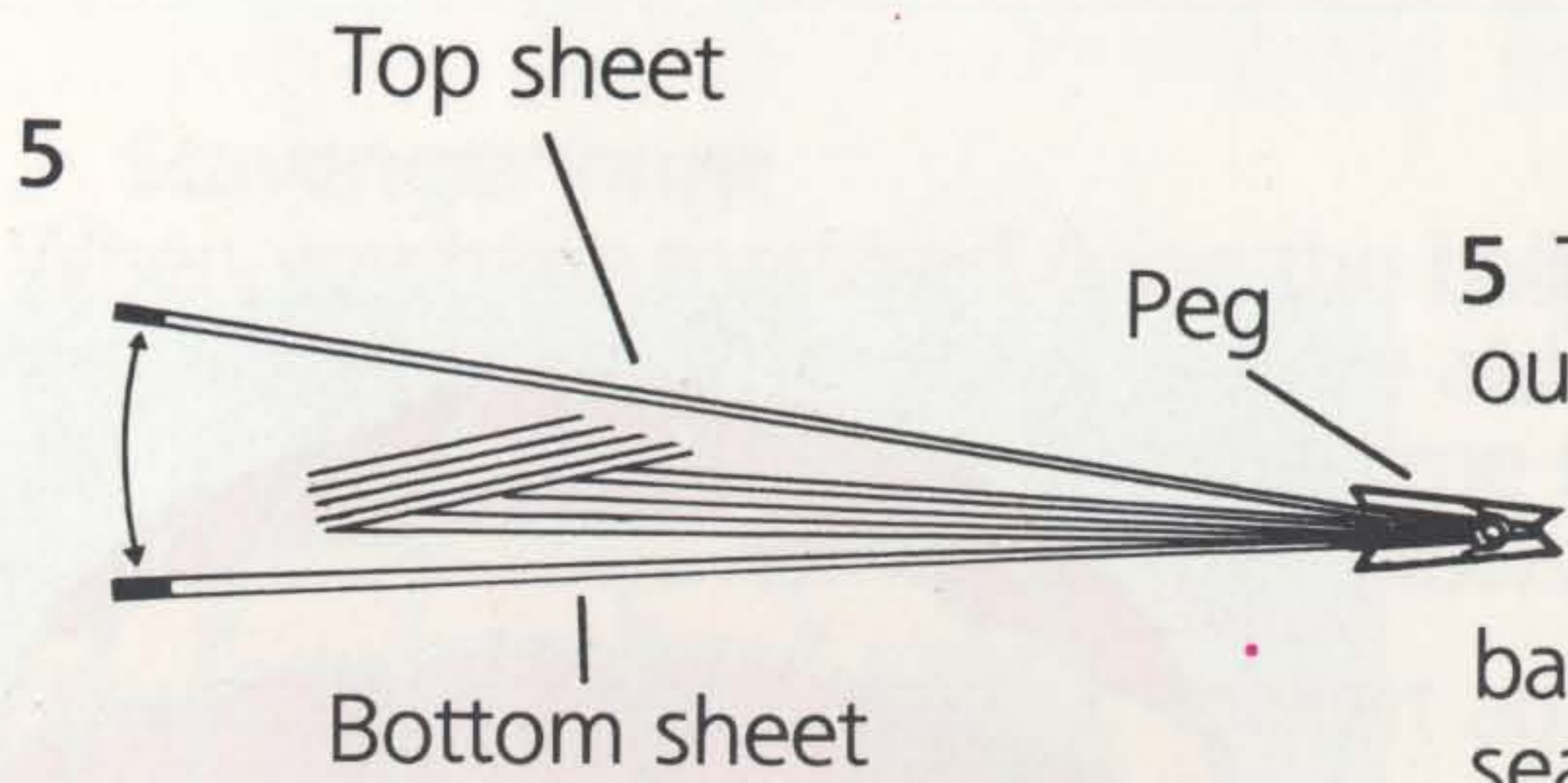
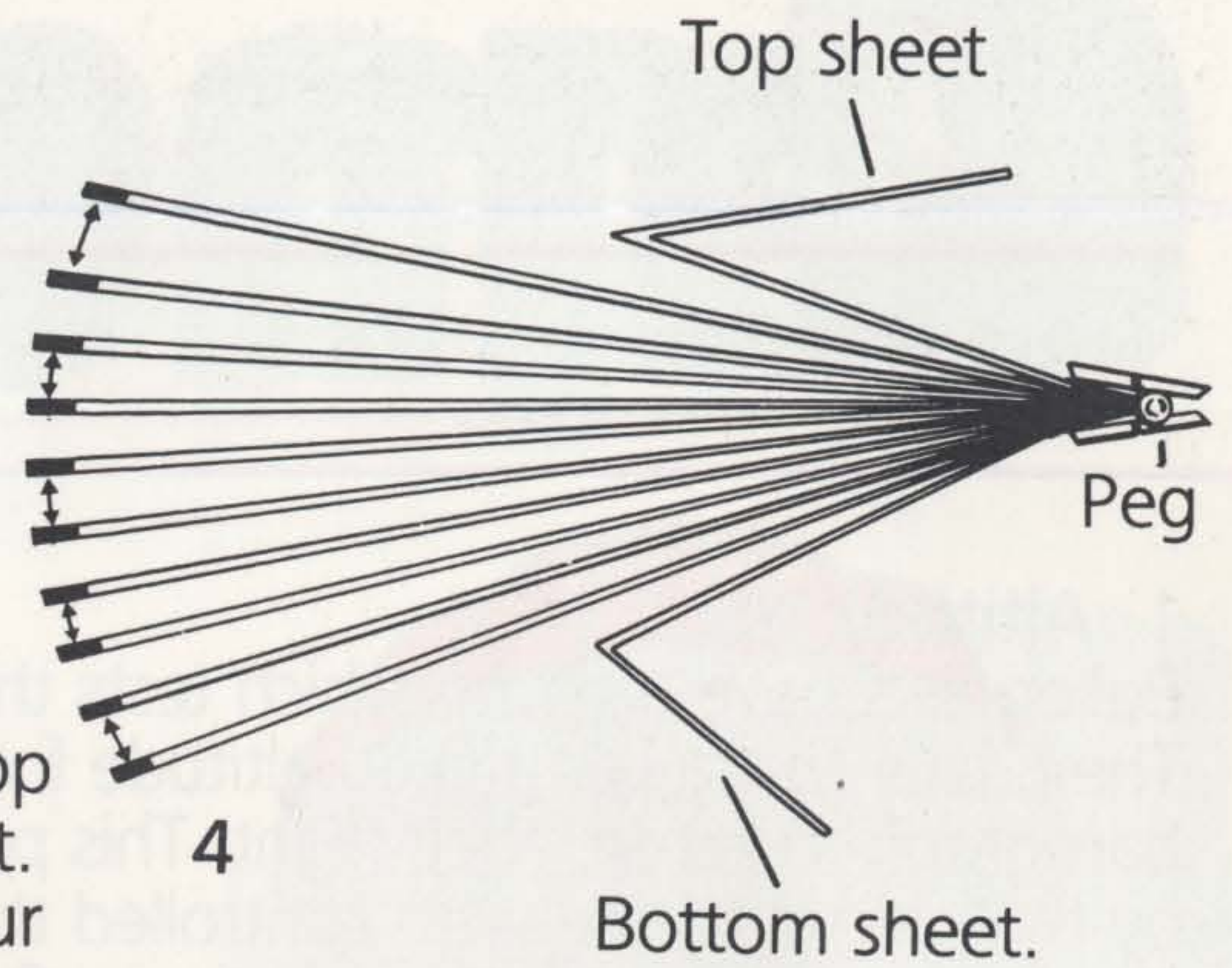

5 Tuck all the glued sheets out of the way and glue the top sheet to the bottom sheet. You can now open out your balloon but keep a lookout for seams becoming unstuck.

6 Use a short length of thin wire to stiffen the mouth of the balloon. You are now ready to fly!

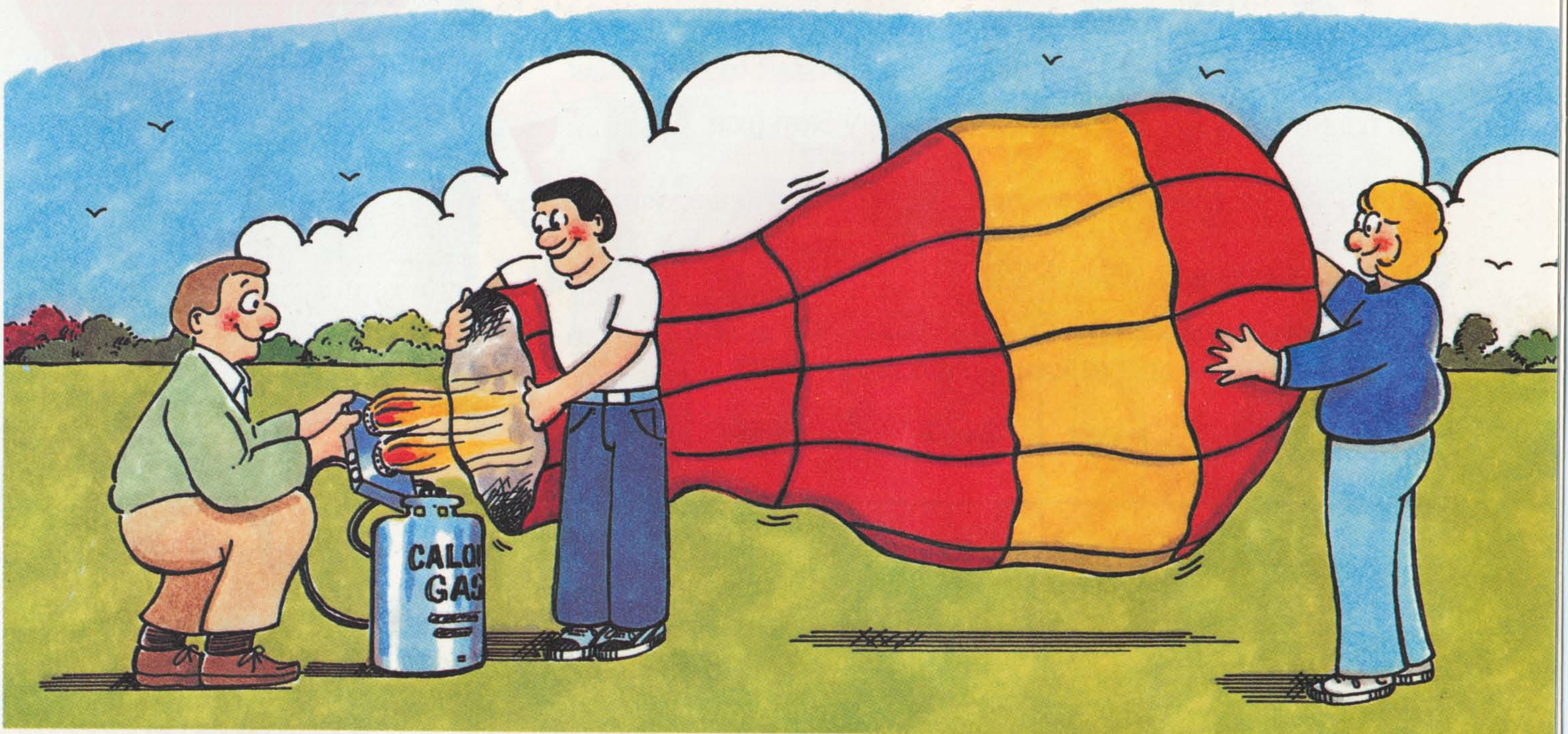

Flying the Balloon

Only try to fly your balloon when the weather is clear and very still. The best source of hot air is a camping stove or blowlamp. You will need an adult to help you keep the tissue away from the heat source. Keep hold of the balloon until you can feel a strong tug from the hot air trying to rise, —then— if the wind will not carry it into trouble let go!

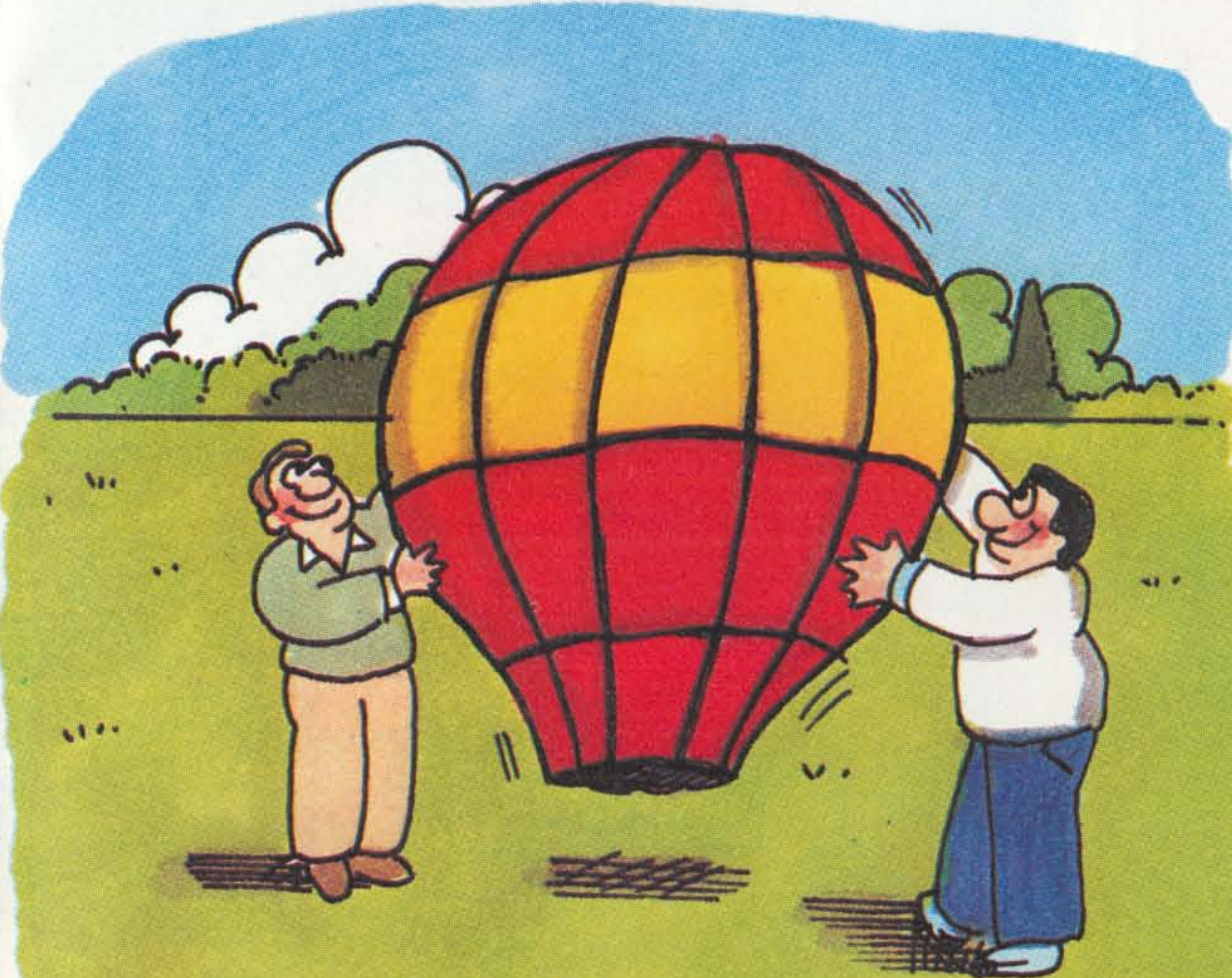

Since your balloon is more than two metres across it has to comply with the Air Navigation Order of 1976 and may not fly in controlled airspace. This includes space near major cities such as London or Birmingham and within 5km of an airfield. Finally, never be tempted to launch the balloon with any form of burner attached. Happy flying!

Games for One

1 Altitude ace

Balloonists have a game which tests their accuracy and skill at flying. They have to stay at a fixed altitude for a certain distance. They use a barograph to record their flight. This produces a trace which is used by the judges to see who controlled their balloon most accurately. The barograph is explained on page 9.

Select the 'Flying school' option and then see if you can follow these flying instructions

fly at 1800 metres for 20 km; then
fly at 1400 metres for 20 km; then
fly at 1000 metres for 20 km.

When you have reached 1800 metres you can start to make your own barograph trace. Stop the balloon every 5km (use **M PAUSE**)

and record your altitude. Then press **C ? CONT** to continue with your

attempt to become an altitude ace.

Plot a graph from the results, like this one below, so that you can see how level you were able to keep your balloon.

ALTITUDE(m)

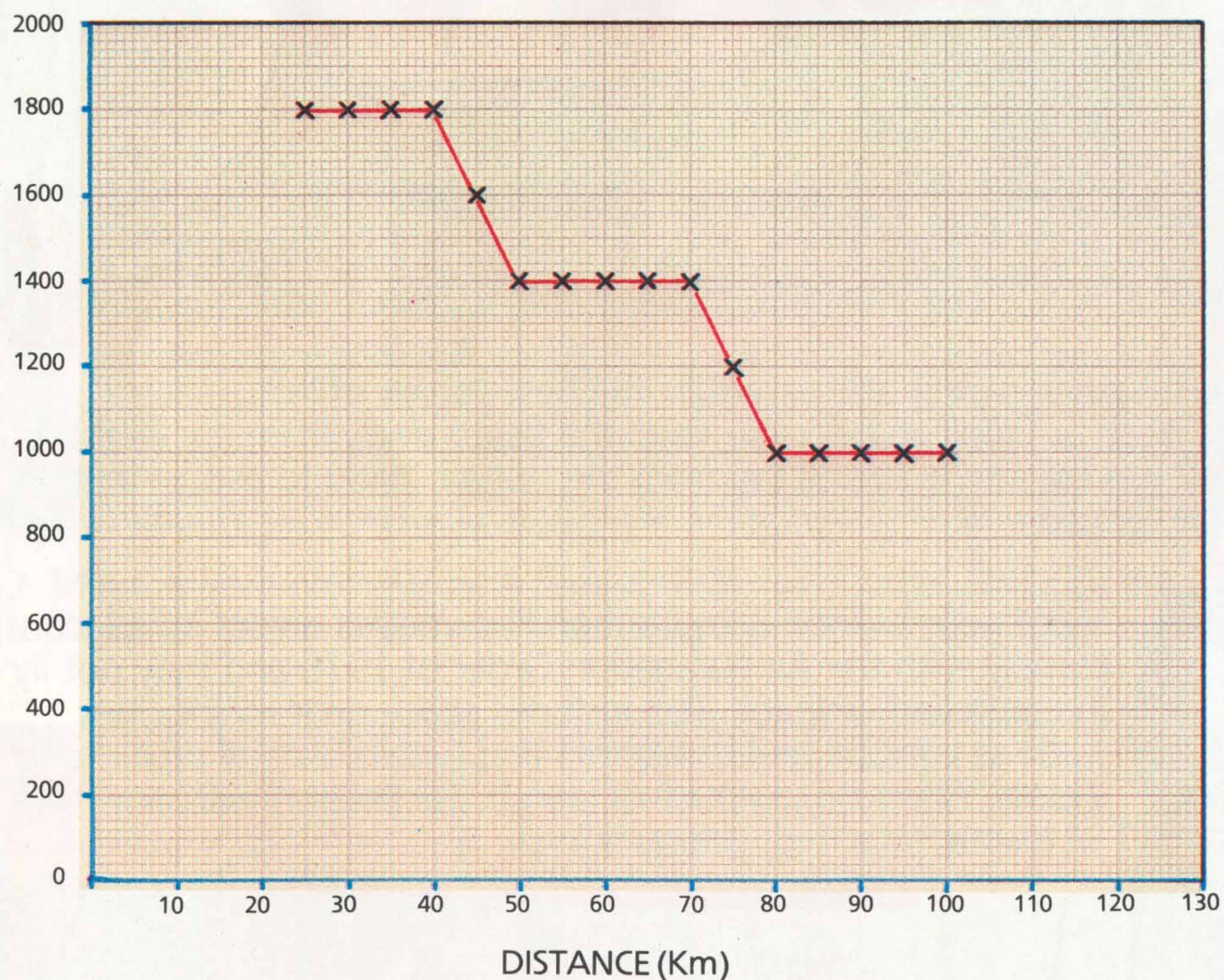

Try the game again, and see if you can make your barograph trace any closer to this graph. You might also like to make up other, more difficult, tests of flying skill for yourself or your friends.

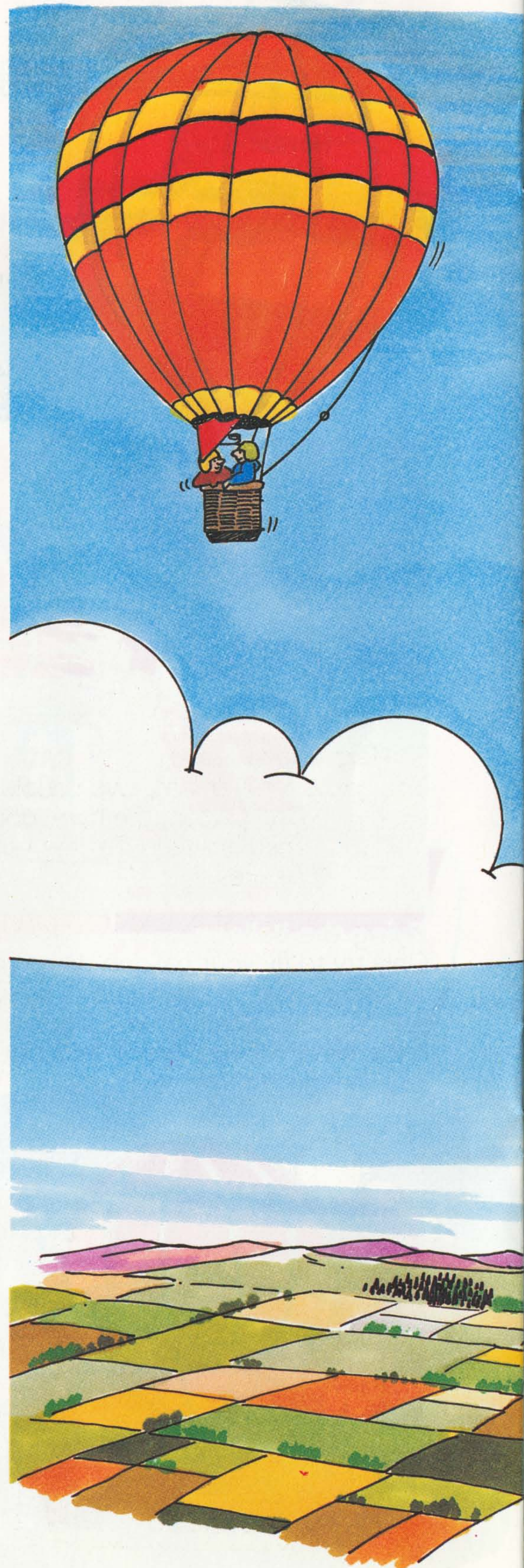

or More People

2 Scavenger hunt

When you have mastered flying the balloon at high altitude, you might like to see how good you are at low-level flying. Again select the 'Flying School' option and this time see how many times you can land **before** the Distance counter shows 75km. After the counter shows 75km, press to start again.

See if you or your friend can land more often than you did. Remember that you can land on any piece of flat ground. But be careful not to come in too quickly and not to land with the burner on! If you do crash, take away 5 from your total number of landings.

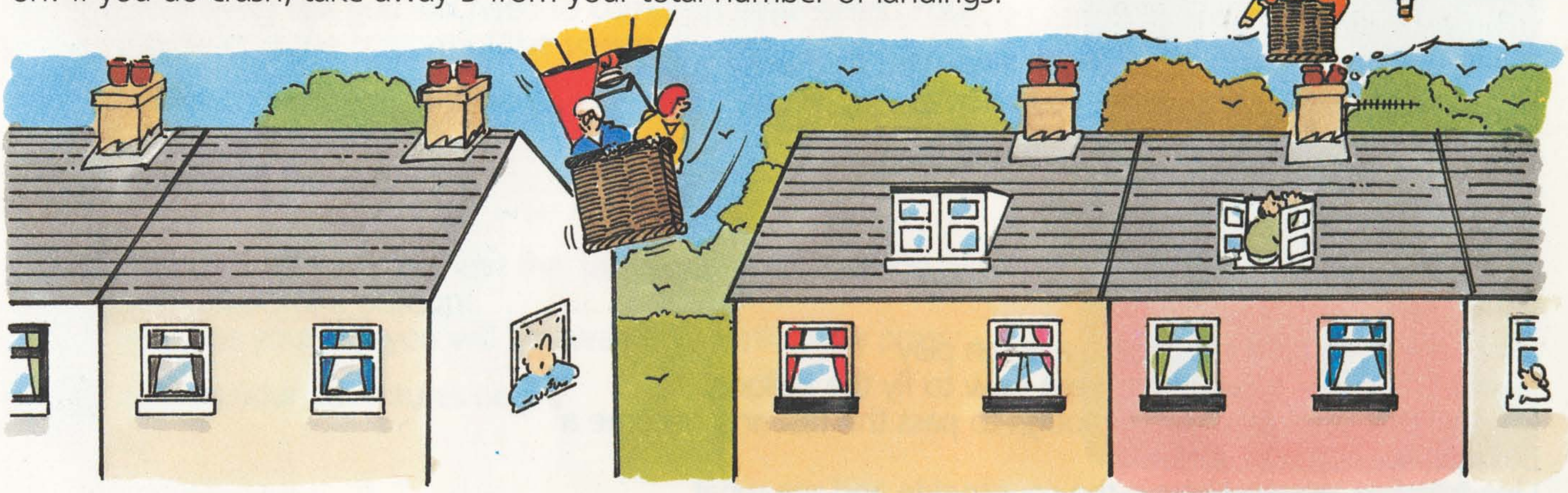

3 Hare and hounds

This game is for at least two people.

One person, the hare, goes first and selects Air cadet. The hare then flies the balloon and lands wherever he likes.

The first hound then presses to start again

(flying over the identical landscape) and selects Pilot officer. The hound has to try to land in exactly the same place as the hare.

Hounds will have to watch out for hazards which may make landing difficult. Try the game again, but this time the hare might want to find a more difficult place to land. The hounds can also choose Balloon ace instead of Pilot officer to make the game even harder.

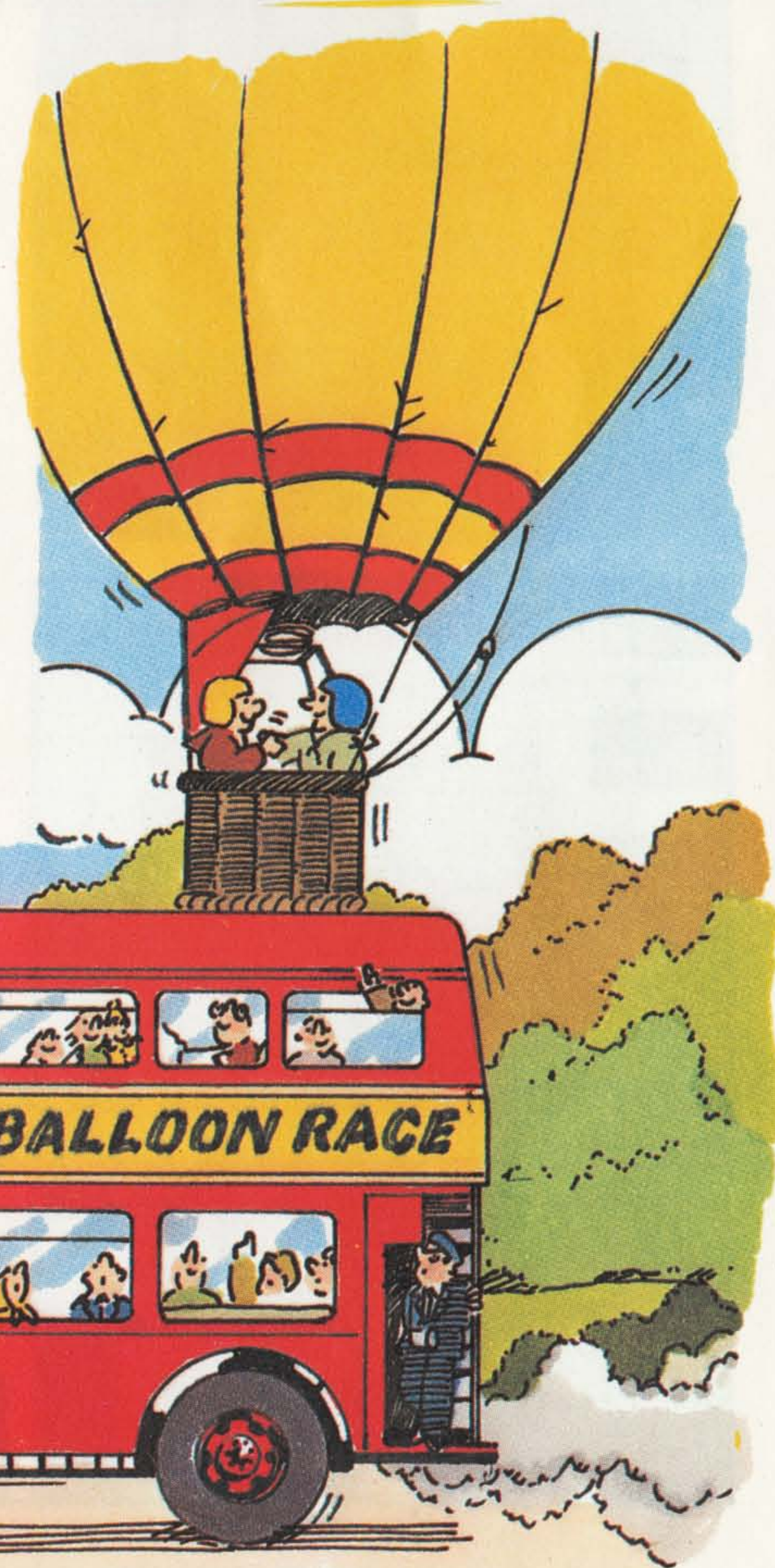

Running th

Imagine you are going on a journey across the countryside in a hot air balloon. You may control the balloon by using the burner and the vent. Switch on the burner to heat the air in the balloon or open the vent to let some of the hot air escape.

1 Choosing your balloon and game

After the introductory screen appears, press:

ENTER to continue.

Two screens will then appear which allow you to choose your balloon and select which game you want to play. Press

BREAK SPACE to choose which you want and then press:

ENTER

There are three different games you can play.

Flying School — a chance to learn how to fly the balloon.

Flying Test — are you good enough to pass the test and become a Balloon Ace?

Live Mission — travel across the countryside and see what adventures you have.

2 Flying school

1 **!** to switch the burner on

2 **o** to switch the burner off

3 **#** to open the vent

4 **S** to close the vent

M PAUSE to stop the balloon

C ? CONT to continue

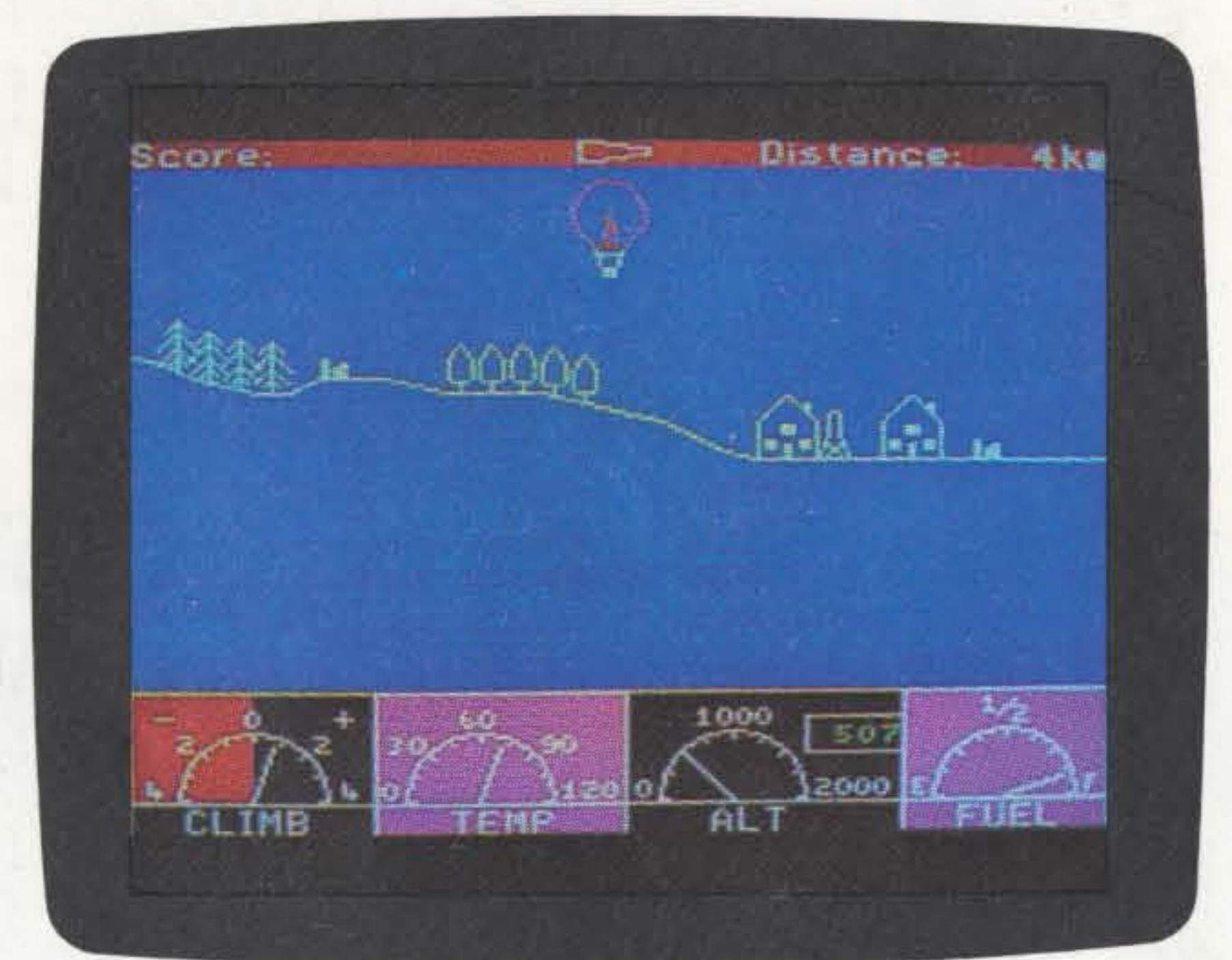

Remember that the more you use the burner, the more fuel you use up. You can refuel if you land close to some gas cylinders. You will see these on the screen like this.

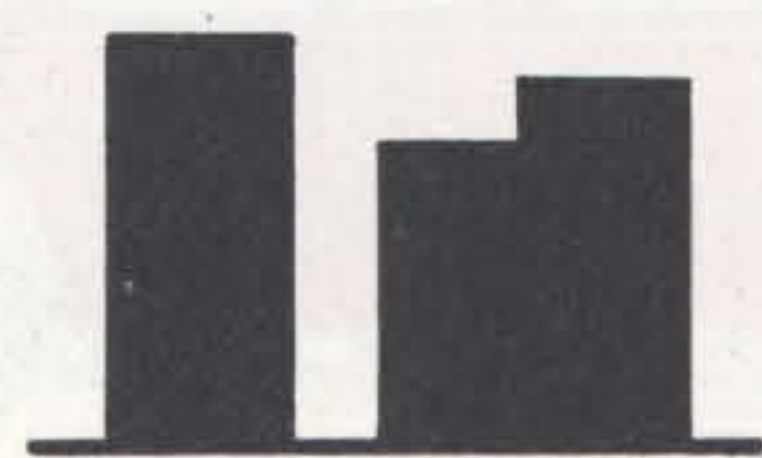



the Program

You should always try to land on a flat piece of ground. Try to come in as slowly as possible, and never land with your burner on. This may cause the balloon to set light and explode! If you do crash you can always press **ENTER** to carry on.

3 Flying test

To pass your flying test you will need to complete three tasks. Your tasks will appear at the bottom of the screen. Press:

6  to see the instrument panel

5  to see the instructions

In each task you will have to show the 'keen examiner' that you are safe at the controls of a balloon!

Should you pass your test you will be awarded a rank. Now press:

ENTER and let your adventures begin.

4 Live mission



Before starting a mission, you must enter your rank. Press:

BREAK SPACE to select your rank and

ENTER to choose the rank shown.

When you are flying the balloon keep a look out for signals:  If you land by one of these signals, you will receive instructions for a task. Below the message will be a symbol showing where you must land to carry out the task. Look out for this symbol as you fly. If you succeed, you will score points, but if you fly over the landing place for your task, you will lose points. You will also lose points if you fly past a signal without stopping to investigate.

Hazards: Pilot Officers and Balloon Aces should look out for hazards, which may cause them problems!

6  to see the instrument panel **7**  to see the hazards

5  to see the instructions

5 Starting again and finishing

0  to start again with the same landscape

CAPS SHIFT **A STOP NEW** to start again with a new landscape

SYMBOL SHIFT **A STOP NEW** to finish

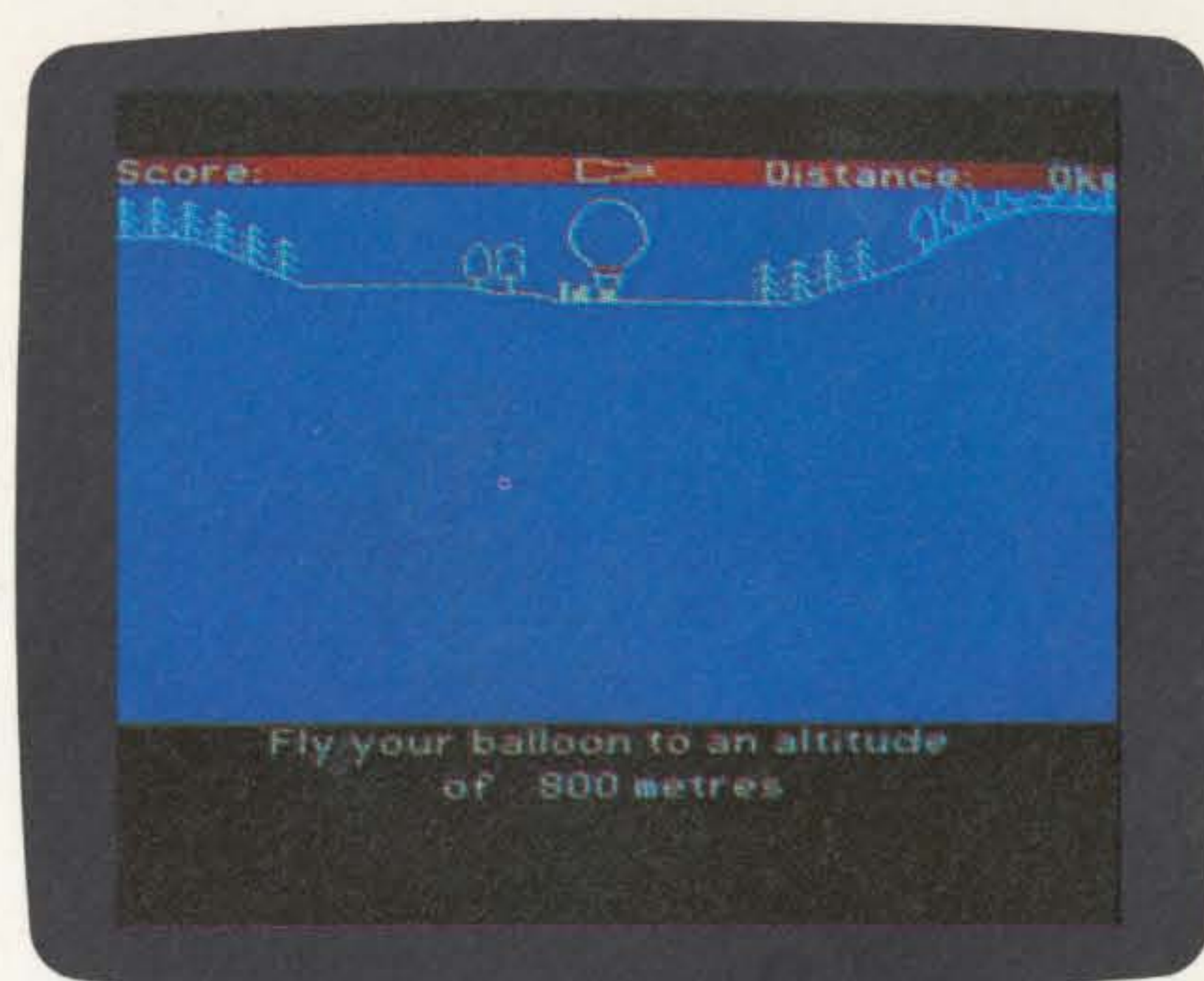

Starting Instructions

- 1 Place cassette in recorder and rewind.
- 2 Press **J LOAD** **SYMBOL SHIFT**
P PRINT **P PRINT**
and then **ENTER**
- 3 Press PLAY on the recorder.
- 4 When the program has finished loading, stop the tape.
- 5 The program will run automatically.

BALLOONING

You are flying high above an unknown landscape in a hot air balloon. Will you have enough fuel to climb over the mountain? Can you land safely, avoiding the trees? Enjoy exploring the science of lighter-than-air flight as you learn to control your balloon on a series of adventures.

While children enjoy mastering this program, they will be encouraged to acquire and practice the following skills:

- * observing closely the readings on the balloon's instruments
- * experimenting with the balloon's controls
- * recording the performance of the balloon to help plan successful journeys

This book will help you make the most of the software. It is packed with information and stories which extend the theme of the program, and many ideas for further activities. Learning has never been so much fun!

Ballooning is one of a series of programs which has been designed by a team of twenty-four teachers and advisers from **Dudley Metropolitan Borough**.

Other titles in the series

CAR JOURNEY

How quickly can you drive from Exeter to Glasgow, without getting caught for speeding and without running out of petrol? What is the best route from Dover to Liverpool, and how much would this journey cost? Travel the roads of Britain, and enjoy finding out!

SPECIAL AGENT

As you chase the enemy agent around Europe, you will need to consult timetables, respond quickly to intelligence reports, and plan your international route. And with only a limited amount of money to spend in tracking him down, careful budgeting is necessary.

PUNCTUATION PETE/WORDFINDER

These two programs will help you improve your English skills. They provide practice in comprehension, punctuation, and finding the right word!



Heinemann

Five Ways

